

**EPSON® PowerLite® 54c/74c
Multimedia Projector**

User's Guide

Important Safety Information

WARNING: Never look into the projector lens when the lamp is turned on; the bright light can damage your eyes. Never let children look into the lens when it is on. Never open any cover on the projector, except the lamp and filter covers. Dangerous electrical voltages inside the projector can severely injure you. Except as specifically explained in this *User's Guide*, do not attempt to service this product yourself. Refer all servicing to qualified service personnel.

WARNING: The projector and its accessories come packaged in plastic bags. Keep plastic bags away from small children to avoid any risk of suffocation.

Caution: When you replace the lamp, never touch the new lamp with your bare hands; the invisible residue left by the oil on your hands may shorten the lamp life. Use a cloth or glove to handle the new lamp.

Copyright Notice

All rights reserved. No part of this publication may be reproduced, stored in a retrieval system, or transmitted in any form or by any means, electronic, mechanical, photocopying, recording, or otherwise, without the prior written permission of SEIKO EPSON CORPORATION. The information contained herein is designed only for use with this EPSON product. EPSON is not responsible for any use of this information as applied to other products.

Neither SEIKO EPSON CORPORATION nor its affiliates shall be liable to the purchaser of this product or third parties for damages, losses, costs, or expenses incurred by purchaser or third parties as a result of: accident, misuse, or abuse of this product or unauthorized modifications, repairs, or alterations to this product, or (excluding the U.S.) failure to strictly comply with SEIKO EPSON CORPORATION's operating and maintenance instructions.

SEIKO EPSON CORPORATION shall not be liable for any damages or problems arising from the use of any options or any consumable products other than those designated as Original EPSON Products or EPSON Approved Products by SEIKO EPSON CORPORATION.

Trademarks

EPSON is a registered trademark of SEIKO EPSON CORPORATION.

EPSON Connection, EPSON Store, and Extra Care are service marks; SizeWise is a trademark; and PrivateLine, Presenters Club, and PowerLite are registered trademarks of Epson America, Inc.

Pixelworks, DNX, and the DNX logo are trademarks of Pixelworks, Inc.

General Notice: Other product names used herein are for identification purposes only and may be trademarks of their respective owners. EPSON disclaims any and all rights in those marks.

C

Contents

<i>Welcome</i>	7
Getting the Most from Your Projector	8
Using Your Documentation	9
Getting More Information	9
Registration and Warranty	10
Unpacking the Projector	10
Additional Components	11
Optional Accessories	12
1 <i>Setting Up the Projector</i>	13
Positioning the Projector	14
Other Installations	15
Connecting to a Computer	16
Connecting the VGA Computer Cable	16
Connecting a Monitor	18
Connecting the Cable for Remote Mouse Control	19
Amplifying Computer Audio	20
Connecting to a High-End Workstation	21
Connecting to Video Sources	22
Connecting a Composite Video Source	22
Connecting an S-Video Source	24
Connecting an RGB Video Source	25
Connecting a Component Video Source	26
2 <i>Using the Projector</i>	27
Turning On Your Equipment	28
Turning On the Projector	28
Selecting the Image Source	30
What To Do If You See a Blank Screen	30

Adjusting the Image	33
Focusing and Zooming Your Image	33
Adjusting the Height of Your Image	34
Adjusting the Image Shape	35
Adjusting the Brightness	36
Adjusting the Color Mode	36
Correcting Computer Images	37
Shutting Down the Projector	37

3

<i>Using the Remote Control</i>	39
Removing the Battery Tape	40
Storing the Remote Control	40
Controlling the Picture and Sound	41
Switching Between Picture Sources	41
Turning Off the Picture and Sound	42
Stopping Action	42
Zooming Your Image	42
Using the Remote Control as a Wireless Mouse	43
Replacing the Battery	44

4

<i>Fine-tuning the Projector</i>	45
Using the Projector's Menu System	46
Changing Menu Settings	47
Adjusting the Image	48
Adjusting the Sound	51
Customizing Projector Features	52
Setting Advanced Features	53
Viewing Lamp Usage and Other Information	55
Creating Your Own Screen Logo	56
Capturing the Image	56
Choosing When to Display the Screen Logo	57
Enabling Password Protection	58
Setting a Password	59
Turning On the Password and User's Logo	59
Starting the Projector with a Password	60
Restoring the Default Settings	61

5	<i>Maintaining and Transporting the Projector</i>	63
	Cleaning the Lens	64
	Cleaning the Projector Case	64
	Cleaning and Replacing the Air Filter	65
	Replacing the Lamp	67
	Resetting the Lamp Timer	69
	Transporting the Projector	70

6	<i>Solving Problems</i>	71
	Using On-Screen Help	72
	What To Do When the Lights Flash	73
	Solving Problems with the Image or Sound	75
	Solving Password Problems	82
	Solving Problems with the Remote Control	82
	Where To Get Help	83
	Telephone Support Services	84

	<i>Appendix A: Technical Specifications</i>	85
--	---	----

	<i>Appendix B: Notices</i>	91
	Important Safety Instructions	91
	Remote Control Information	93
	Declaration of Conformity	94
	FCC Compliance Statement	95
	Warranty	96

	<i>Index</i>	99
--	------------------------	----

W *Welcome*

The EPSON® PowerLite® 54c and 74c are micro-portable projectors that offer up to 2000 ANSI lumens of brightness. From classrooms to auditoriums, your full-color presentations and videos will be bright and visible even in ordinary indoor lighting.

Images are displayed at a resolution of 800 × 600 pixels (PowerLite 54c) or 1024 × 768 pixels (PowerLite 74c). Three 0.7-inch LCDs provide a 500:1 contrast ratio for incredibly vivid images and clear text. Support for S-Video contributes to theater-quality performance.

You can connect the projector to a wide range of computers, including IBM®-compatible PCs and laptops, Apple® Macintosh®, Power Macintosh® series (including G3 and G4 systems), PowerBook® computers, many iMac® and iBook® series systems, and high-end workstations such as the Sun® SPARCstation.™ With EPSON's patented SizeWise™ technology, the projector supports computer displays ranging from VGA through UXGA.

You can use any of the following video sources: HDTV, VCR, DVD player, gaming console (such as Microsoft® Xbox,™ Sony® PlayStation® 2, and Nintendo GameCube™), camcorder, digital camera, or laser disc player. The projector supports NTSC, PAL, and SECAM video formats.

Two devices can be connected to the projector at the same time; either two computers, two video sources, or one of each. The source buttons let you easily switch between them.

To safeguard your projector, you can set a password to control who uses it, and create your own screen logo which cannot be disabled by unauthorized users.

Getting the Most from Your Projector

Depending on your presentation, you can take advantage of any or all of these options:

- **Connecting to a laptop or other computer**

If you want to connect the projector to a laptop or desktop computer, see page 16. For additional presentation control, you can connect the USB cable to the projector for running slide shows, and connect an external monitor to view the presentation on your computer simultaneously.

- **Connecting to video sources**

You can connect a DVD player, VCR, HDTV, camcorder, laser disc player, digital camera, and other video sources to your projector. See page 22 for instructions.

- **Using the remote control**

The remote control lets you switch from computer to video sources, zoom in on part of your image, freeze or mute the presentation, and adjust many other projector features. For details, see Chapter 3.

By connecting an additional cable, you can also use the remote control as a wireless mouse. This lets you click through computer-based presentations (such as PowerPoint®) from up to 20 feet away. For more information, see page 43.

- **Including sound in your presentation**

If your presentation includes sound, you can connect an optional audio cable to use the projector's built-in speaker. See page 20.

note

Many of the projector's features can only be accessed with the remote control. To avoid losing the remote control, place it in the remote control storage compartment beneath the side of the projector.

Using Your Documentation

Your Start Here kit includes a *Quick Setup* sheet, warranty brochures, and EPSON PrivateLine® Support card. Store this *User's Guide* in the envelope and keep the envelope with your projector at all times.

The *Quick Setup* sheet gives instructions to quickly set up your projector and connect it to a laptop or PowerBook computer.

This book contains all the information you need to set up and use your projector. Please follow these guidelines as you read through it:

- **Warnings** must be followed carefully to avoid bodily injury.
- **Cautions** must be observed to avoid damage to your equipment.
- **Notes** contain important information about your projector.

Getting More Information

Need tips on giving presentations? How about quick steps for setting up your projector? Here's where you can look for help:

- **www.presentersonline.com**
Includes a library of articles covering presentation tips, tricks, and technology. The site provides templates, clip art and sound clips, as well as Presenters Services to use on the road. Even more resources and services are available if you register to join the Presenters Club®—and it's free.
- **Built-in help system**
Press the **Help** button on the remote control to get quick solutions for common problems. See page 72 for details.
- **support.epson.com**
Download FAQs (frequently-asked questions) and e-mail your questions to EPSON support.

If you still need help after checking this *User's Guide* and the sources listed above, you can use the EPSON PrivateLine Support service to get help fast. Call (800) 637-7661 and enter the PIN on the card in your Start Here kit. See page 83 for more information.

Registration and Warranty

Your projector comes with a basic carry-in warranty and an international warranty that let you project with confidence anywhere in the world. For details, see page 96 and the warranty brochure included in your Start Here kit.

In addition, EPSON offers free Extra CareSM Road Service. In the unlikely event of an equipment failure, you won't have to wait for your unit to be repaired. Instead, EPSON will ship you a replacement unit anywhere in the United States or Canada, usually via overnight delivery. See the brochure in your Start Here kit for details.

To register, complete the registration form in your Start Here kit and mail it to EPSON. Or register your product online at:

<http://www.epson.com/webreg>

Registering also lets you receive special updates on new accessories, products, and services.

Unpacking the Projector

After unpacking the projector, make sure you have all these items:

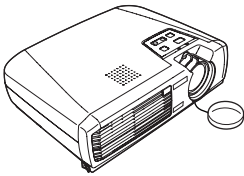

Projector

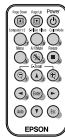

Remote control



Documentation



Soft carrying case



Power cord

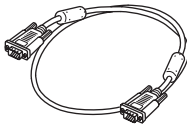

VGA computer cable

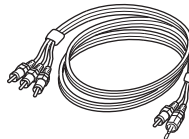

RCA A/V cable

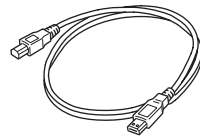

USB mouse cable

Save all packaging in case you need to ship the projector. Always use the original packaging (or equivalent) when you need to send the projector to another location.

If you are moving the projector by hand, use the carrying case included with the projector.

Additional Components

Depending on how you plan to use the projector, you may need additional components:

- To receive an S-Video signal, you need an S-Video cable. One is usually provided with your video device, or you can purchase it from EPSON. See page 12.
- To receive a component video signal from a VCR or other video device, you need a D-sub, 15-pin, VGA-to-component video cable, which is available from EPSON. See page 12.
- To amplify your computer's audio through the projector's sound system, you need a computer audio cable (male-to-male 3.5-mm stereo miniplug cable). See your computer or electronics dealer to obtain this cable.
- Some older PowerBooks and Macintosh desktop models may need the Macintosh adapter set shown on page 17 (available from EPSON, as described on page 12). Older iMac systems may need a special adapter to provide a VGA output port; see your computer dealer.

Optional Accessories

To enhance your use of the projector, EPSON provides the following optional accessories:

Product	Product number
Replacement lamp	V13H010L27
Air filter set (includes 5 filters)	V13H134A05
Samsonite® wheeled soft case	ELPKS24
Soft shoulder bags (projector/laptop)	ELPKS43
ATA molded hard-shell carrying case	ELPKS45
Replacement remote control	V12H007T13
Component video cable (VGA-to-RCA)	ELPKC19
S-Video cable	ELPSV01
Macintosh adapter set	ELPAP01
50-inch portable screen	ELPSC06
60-inch portable pop-up screen	ELPSC07
80-inch portable pop-up screen	ELPSC08
High resolution document imager	ELPDC02
High resolution document camera	V12H064020
Kensington® security lock	ELPSL01
Ceiling mount	ELPMB39
False ceiling plate	ELPMBFCP
Suspension adapter	ELPMBAPL

You can purchase these accessories from your dealer, by calling EPSON at (800) 873-7766, or by visiting the EPSON StoreSM at www.epsonstore.com (U.S. sales only). In Canada, please call (800) 463-7766 for dealer referral.

1 *Setting Up the Projector*

This chapter tells you how to set up the projector and connect it to a computer or video source. You can connect up to two devices simultaneously: two computers or two video sources or one of each.

You'll find instructions for the following in this chapter:

- Positioning the projector
- Connecting to a computer
- Connecting to video sources

Positioning the Projector

Before connecting the projector, you need to decide where to place it. If you're setting up the projector yourself and it isn't already installed in the room you're using, you'll probably want to place it on a table in front of the screen, as shown.

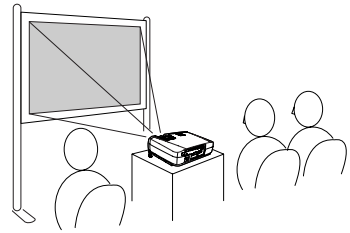

This lets you stand in the front of the room, face the audience, and remain close enough to the equipment to be able to control it. Try to leave as much space as possible between the projector and the screen to get a good-size image.

Place the projector somewhere between 3 and 35 feet from the screen. Use the figure below to help you determine exactly how far. Image size increases with distance, but can vary depending on how you've adjusted the optical zoom and other settings.

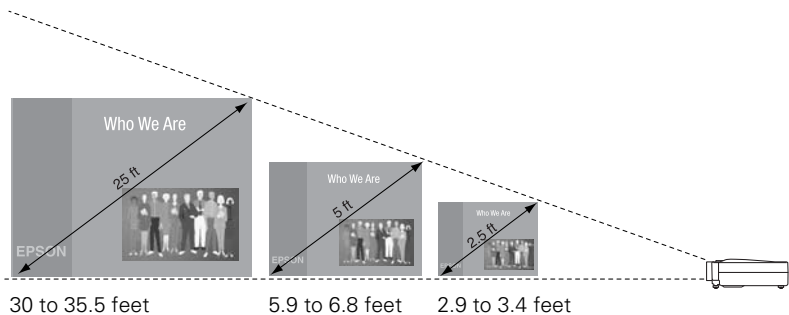

note

You can download the *Projection Distance Calculator* program from the *Drivers and Downloads* section of EPSON's web site: <http://epson.com>.

Also keep these considerations in mind:

- Place the projector on a sturdy, level surface.
- Make sure there is plenty of space for ventilation around and under the projector. Do not set the projector on top of loose papers that could block the vents under the projector.
- Make sure the projector is within 6 feet of a grounded electrical outlet or extension cord.

Try to place the projector directly in front of the center of the screen, facing it toward the screen squarely. If the projector isn't positioned this way, the image will be "keystone" shaped, instead of square or rectangular.

If you place the projector below the level of the screen, you'll have to tilt it up by extending the feet. This also causes the image to lose its rectangular shape, but the Auto Keystone feature corrects the distortion automatically. If the image does not regain its rectangular shape, the tilt angle is greater than 15° or the Auto Keystone feature may have been disabled. To turn it on, see page 52. To adjust it manually, see page 35.

note

The Auto Keystone feature corrects vertical distortion automatically. For more information, see page 35.

Other Installations

You can also project from behind the screen or from the ceiling, with the projector mounted upside-down:

Rear projection (using a translucent screen)

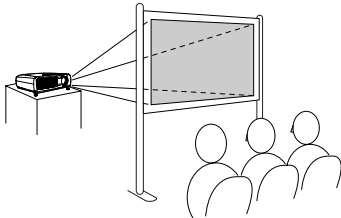

Rear/ceiling projection (using a translucent screen)

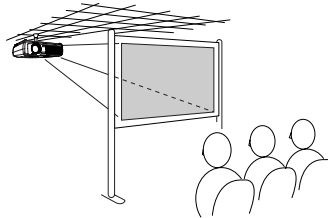

Front/ceiling projection

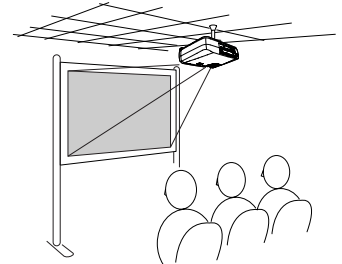

To project from overhead, you'll need the optional ceiling mount hardware. (See page 12 for ordering information.) You'll also need to select **Front/Ceiling** or **Rear/Ceiling** for the **Projection** option in the **Advanced** menu. To project from the rear, select **Rear**. See page 53 for more information.

Connecting to a Computer

note

If you have an iBook with an RCA video-out port, follow the instructions for connecting to a video device on page 22.

You can connect the PowerLite projector to any Macintosh or IBM®-compatible PC that has a standard video output (monitor) port, including PC notebook and laptop computers, Macintosh PowerBooks and iBooks, and hand-held devices. You can connect two computers at the same time.

Follow the instructions in this section to:

- Connect the VGA computer cable to the projector
- Connect your computer's monitor cable to the projector (if you want to view your display on the desktop computer screen)
- Connect the mouse cable (if you want to use the remote control as a mouse)
- Connect an optional audio cable (if you'll be projecting with audio)

Connecting the VGA Computer Cable

Before you start, make sure your computer and the projector are turned off.

1. If you are connecting the projector to a desktop computer, disconnect the monitor cable from your computer.
2. Locate the VGA computer cable that came with the projector.

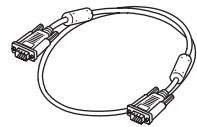

VGA computer cable

note

If your computer provides video output through BNC connectors, you can use the optional VGA-to-BNC cable instead. See page 12.

3. Connect one end of the cable to the projector's **Computer1/Component Video1** or the **Computer2/Component Video2** port. If you are going to connect your computer monitor to the projector for simultaneous display, use the **Computer1/Component Video1** port.

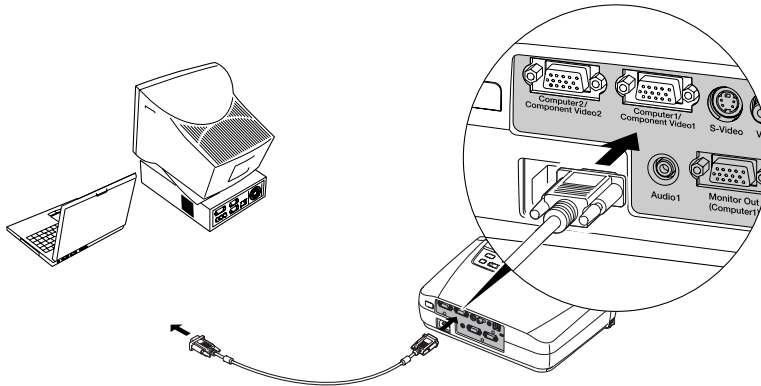

4. Connect the other end of the cable to your computer's video-out or monitor port.

If you're using a PowerBook or iBook and you can't connect the cable, you may need to use the Macintosh desktop adapter as shown below (available from EPSON; see page 12).

To use the adapter, remove its cover as shown and set its DIP switches according to the resolution you want to use, such as 16-inch mode. See your Macintosh documentation for instructions.

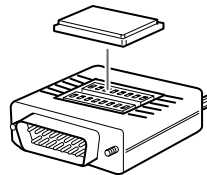

Replace the cover and connect the adapter to the free end of the computer video cable. Then plug the cable (with the adapter) into the video port on your Macintosh.

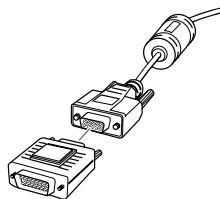

5. If you want to view the display simultaneously on your computer monitor and the projector screen, see "Connecting a Monitor" on page 18.
6. Tighten the screws on the connectors.

After projection starts, select the correct source (either **Computer1** or **Computer2**) when you want to project this source. See page 30.

If you don't need to make any other connections, you can plug in your projector and turn it on. See page 28 for instructions.

Connecting a Monitor

note

Some LCD monitors may not be able to display the image correctly. If you have trouble displaying the image, connect a multiscan monitor. If you're projecting computer images, make sure the computer's refresh rate is set to 65 Hz or greater.

If you want to see your presentation close-up as well as on the screen, you can connect an external monitor to the projector. This lets you view images on your computer monitor while the projector is in standby mode (plugged in but not turned on) and check your presentation or switch between picture sources even if you've pressed the **A/V Mute** button to turn off projection on the screen.

Simultaneous display is possible only when the computer is connected to the projector's **Computer1/Component Video1** port.

Make sure the projector and computer are off. Then connect the monitor's cable to the projector's **Monitor Out** port, as shown:

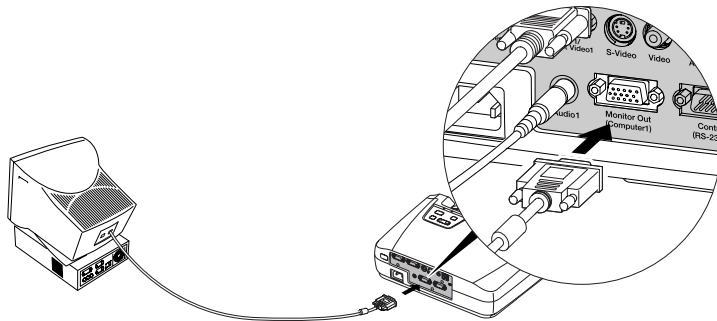

If you don't need to make any other connections, you can plug in your projector and turn it on. See page 28 for instructions.

Connecting the Cable for Remote Mouse Control

Using the remote control as a wireless mouse lets you click through slideshow-style presentations, such as PowerPoint, from up to 20 feet away. This makes it easy to deliver your presentation, since you won't need to stand near your computer.

To use the wireless mouse function, your system must have a USB port and the full version of one of these operating systems:

Windows	Macintosh
Windows 98, 2000, Me, and XP	Macintosh OS 8.6 to 9.2, OS X

1. If you are using a desktop computer, disconnect the mouse cable from your computer.
2. Locate the USB mouse cable that came with the projector and connect the square end of the cable to the projector's  USB port.

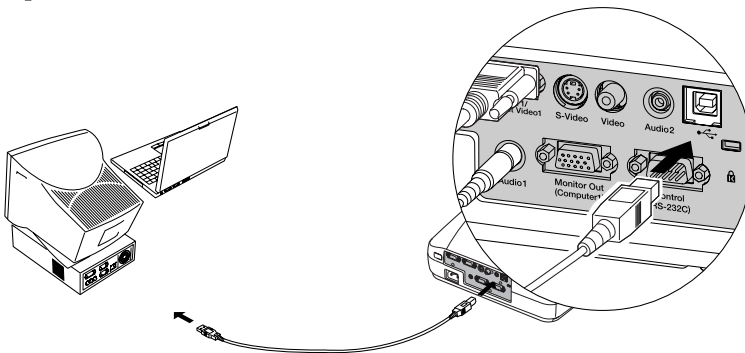

3. Connect the flat end of the cable to an available USB port on your computer.
4. If necessary, configure your laptop to work with an external mouse.



If you don't need to make any other connections, you can plug in your projector and turn it on. See page 28 for instructions.

Amplifying Computer Audio

Your computer probably has its own sound system; however, it may not be adequate for your presentation. If you need more volume, you can connect a computer audio cable to take advantage of the projector's built-in amplifier and speaker. You can obtain a computer audio cable (3.5-mm stereo miniplug cable) from a computer or electronics dealer.

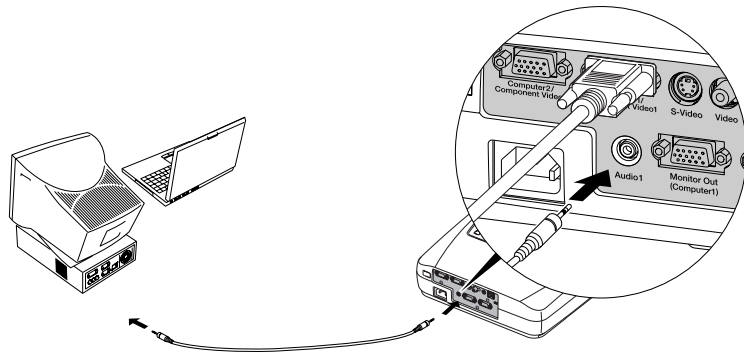
1. Connect one end of the audio cable to the **Audio1** jack on the projector.



2. Connect the other end of the audio cable to your laptop's  headphone jack or  audio-out jack, or your desktop's speaker or audio-out port.
3. After you turn on your projector, open the Audio menu and make sure **Audio 1** is selected for the Audio Input setting. See page 51.

note

The Audio menu also lets you adjust the volume.

If you don't need to make any other connections, you can plug in your projector and turn it on. See page 28 for instructions.

Connecting to a High-End Workstation

Your PowerLite projector is capable of remapping input resolutions up to 1600×1200 pixels (on the PowerLite 74c) or up to 1280×1024 pixels (on the PowerLite 54c). Since 1280×1024 pixels is the default resolution for most leading workstations, your projector is ideal for displaying workstation video output.

There is no standard for workstation video output. Workstations that follow the SXGA standard and use the HD15 (standard VGA) connector won't need an adapter cable or any special connection device. However, your system may vary; contact your computer dealer if you need help connecting your workstation.

Connecting to Video Sources

You can connect a DVD player, VCR, camcorder, laser disc player, digital camera, gaming console—such as Microsoft Xbox, Sony PlayStation 2, or Nintendo GameCube—or any other compatible video source to your projector. You can connect up to two video devices at time (or one computer and one video device).

note

The projector does not support TV antenna cable F connectors.

The projector supports HDTV, NTSC, PAL, and SECAM, and automatically detects the video format. It can receive composite video, S-Video, and component video. The type of cable you need depends on the video source:

- For composite video, use the RCA A/V cable included with the projector. See below.
- For S-Video, use the S-Video cable supplied with your video device or order one from EPSON (ELPSV01). See page 24.
- For RGB video, use the VGA computer cable included with the projector. See page 25.
- For component video, you'll need the optional EPSON component video cable (ELPKC19). See page 26.

Connecting a Composite Video Source

Before starting, make sure the projector and your DVD player or other video source are turned off.

1. Locate the RCA A/V cable that came with your projector.

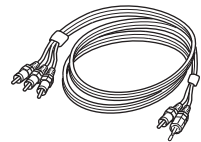

2. Connect the yellow RCA plug on the two-connector end of the cable to the projector's yellow **Video** jack as shown below.

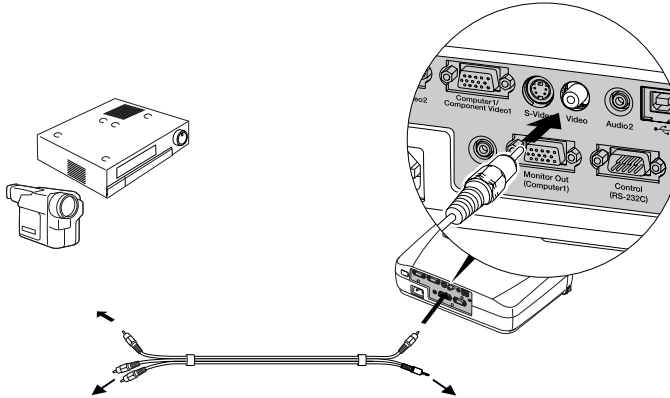

3. Connect the other yellow plug to the video-out jack on your video source.
4. To play sound through the projector, connect the black audio plug on the RCA A/V cable to the projector's **Audio2** jack.

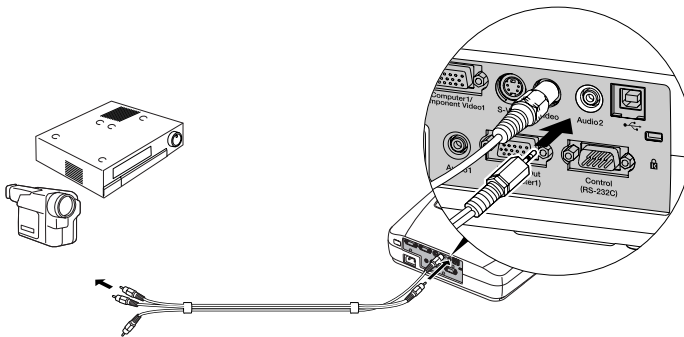

5. Connect the red and white plugs on the other end of the cable to the corresponding audio output jacks on your video source.
6. After you turn on your projector, be sure to:
 - If more than one device is connected to the projector, select **Video** when you want to project this source. See page 30.
 - Open the Audio menu and make sure **Audio 2** is selected for the **Audio Input** setting. See page 51.

note

The Audio menu also lets you adjust the volume.

Connecting an S-Video Source

If your video source has an S-Video jack, you can use it to project a higher quality video image. You'll need an S-Video cable, which is usually provided with your video source, or you can purchase one from EPSON. See page 12.

Before starting, make sure the projector and your DVD player or other video source are turned off.

1. Insert one end of the S-Video cable into the projector's **S-Video** port and the other end into the S-Video output port of your video source.

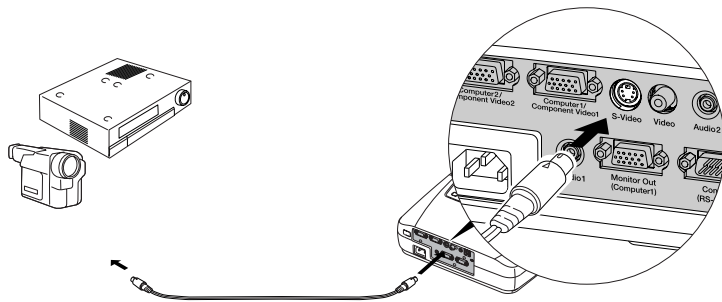

2. If you want to play sound through the projector, connect the audio plugs on the RCA A/V cable as described on page 22.
3. After you turn on your projector, be sure to:
 - If more than one device is connected to the projector, select **S-Video** when you want to project this source. See page 30.
 - Open the Audio menu (if you connected the audio cable) and make sure **Audio 2** is selected for the **Audio Input** setting. See page 51.

Connecting an RGB Video Source

Follow these instructions to connect the projector to a video player that has an RGB video output port using the VGA computer cable that came with the projector.

1. Connect one end of the VGA computer cable to the **Computer1/Component Video1** or the **Computer2/Component Video2** port on the projector.

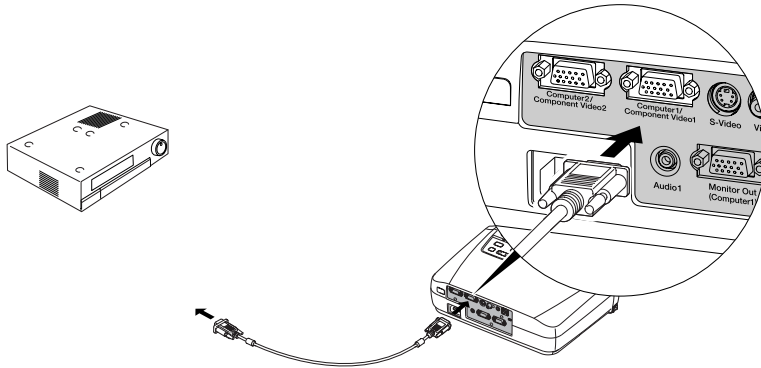

2. Connect the other end to the video port on your player.
3. If you want to play sound through the projector, connect the optional audio cable (3.5-mm stereo miniplug) as described on page 20.

Once the projector is turned on, be sure to select **Computer 1** or **Computer 2** (whichever port you used) as the source to see your image. See page 30.

Connecting a Component Video Source

If your video source has component video connectors, you can use them to project a higher quality video image. You'll need a component video cable, which can be purchased from EPSON (ELPKC19). See page 12.

Before starting, make sure the projector and your DVD player or other video device are turned off.

1. Connect the large end of the component video cable to the projector's **Computer1/Component Video1** or the **Computer2/Component Video2** port.

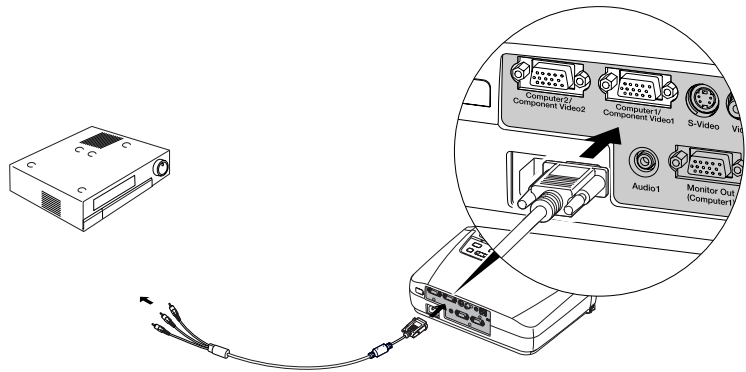

2. Insert the three ends of the component video cable into the **R**, **G**, and **B** ports on your video source.
3. Connect the audio plugs on the RCA A/V cable as described on page 22.
4. Once the projector is turned on, be sure to:
 - Select the correct source to see your image: **Component Video1 (YCbCr)**, **Component Video1 (YPbPr)**, **Component Video2 (YCbCr)**, or **Component Video2 (YPbPr)**. See page 50.
 - Open the projector's **Image** menu and select the correct **Input Signal** setting to match your device and the port you used: **Component Video1 (YCbCr)**, **Component Video1 (YPbPr)**, **Component Video2 (YCbCr)**, or **Component Video2 (YPbPr)**. See page 50.

2

Using the Projector

Once you've set up the projector, you're ready to turn it on, adjust the image, and give your presentation.

Although you can operate the projector without it, the remote control lets you use additional features. See Chapter 3 for instructions on using the remote. This chapter covers the following:

- Turning on the projector and other equipment
- Adjusting the image
- Shutting down the projector

Turning On Your Equipment

Make sure your projector and other equipment are set up and connected correctly, as described in Chapter 1. Then turn on your projector, as described below.

If you turn on your connected computer or video equipment before starting the projector, the projector automatically detects and displays the image source. If you turn on the projector first, or have multiple pieces of connected equipment, you may have to select the image source manually. See page 30.

Turning On the Projector

Follow these steps to plug in and turn on the projector:

1. Remove the lens cap.

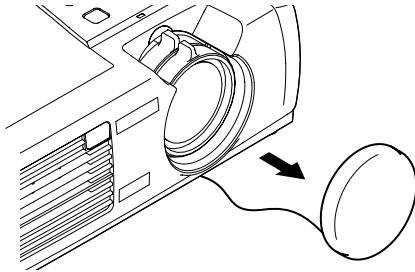

2. Connect one end of the power cord to the projector's power inlet.

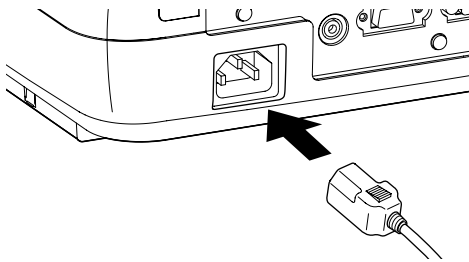

3. Connect the other end to an electrical outlet.

The power light on top of the projector turns orange, indicating that the projector is receiving power but not yet turned on. Wait until the light stops flashing but stays lit orange.

caution

Do not use the projector with the lens cap in place. The heat generated by the lamp can damage it.

4. Turn on your computer or video source if you have not already.
5. Press the **Power** button on top of the projector to turn it on. (You can also press the **Power** button on the remote control.)

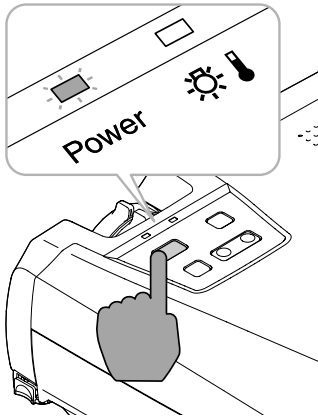

Projector

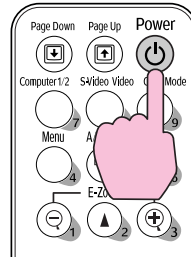

Remote control

The projector beeps and the power light flashes green as the projector warms up. The lamp comes on in about 30 seconds and the power light stays green.

- If you're using a computer, you should see your computer display projected after a moment or two. If not, you need to select the image source. See page 30.

(Windows® only: If you see a message saying that it has found a plug-and-play monitor, click **Cancel**.)

- If you're projecting a video, press the **Source** button on top of the projector or the **S-Video/Video** button on the remote control to switch to your video source. Then press the **Play** button on your DVD player or other device.
- If you are prompted to enter a password, see page 60.

To focus and adjust the image, see page 33. If a projected image fails to appear, see “What To Do If You See a Blank Screen” below.

When you're done with your presentation, shut down the projector as described on page 37. Shutting down the projector correctly prevents premature lamp failure and possible damage from overheating.

note

If you are using the remote control for the first time, be sure to remove the tape from the battery tray as described on page 40.

warning

Never look into the lens when the lamp is on. This can damage your eyes, and is especially dangerous for children.

Selecting the Image Source

Selecting the image source lets you switch between images input from different pieces of equipment connected to the projector (such as a computer and DVD player). If you don't see the image you want, select it as follows:

- On the projector, press the **Source** button until the correct device image is projected.
- On the remote control, press the **Computer1/2** button to select the device connected to the Computer1/Component Video1 or Computer2/Component Video2 port. For the S-Video or Video port device, press the **S-Video/Video** button.

If a projected image fails to appear, see the next section for help.

Once you see your image, turn to page 33 for instructions on focusing and making other image adjustments.

note

If you don't hear any sound and adjusting the volume controls does not help, you may need to select the correct Audio port. See page 51.

What To Do If You See a Blank Screen

If you see a blank screen or a blue screen with the message **No Signal** after turning on your computer or video source, try the following:

- Make sure the cables are connected correctly, as described in Chapter 1.
- Make sure the power light is green and not flashing and the lens cap is off.
- Press the **Source** button on top of the projector to select the correct source. (Allow a few seconds for the projector to sync up after pressing the button.)
- Check the **Input Signal** setting in the Image menu to make sure it matches the port to which the device is connected. See page 50.

If you're using a PC laptop:

- Hold down the **Fn** key and press the function key that lets you display on an external monitor. It may have an icon such as  or it may be labelled **CRT/LCD**. Allow a few seconds for the projector to sync up after pressing it. Check your laptop's manual or online help for details.

On most systems, the  or **CRT/LCD** key lets you toggle between the LCD screen and the projector, or display on both at the same time.

- If you're projecting from a laptop, and you don't see the same image on the projection screen and computer screen, check your monitor settings to make sure both the LCD screen and the external monitor port are enabled.

From the Control Panel, open the **Display** utility. Click the **Settings** tab, then click **Advanced**. The method for adjusting the settings varies by brand; you may need to click a **Monitor** tab, then make sure the external Monitor port is set as your primary display and/or enabled. See your computer's documentation or online help for details.

If you're using a Macintosh laptop with OS X:

You may need to set up your system to display on the projector screen as well as the LCD screen. Follow these steps:

1. From the Apple menu, select **System Preferences**, then click **Displays**.
2. Select **VGA Display** or **Color LCD**, click **Arrange** or **Arrangement**, and make sure **Mirror Displays** is checked.

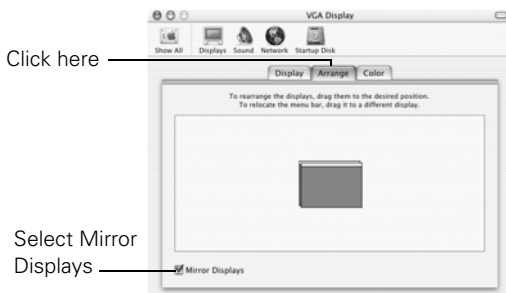

If you're using a Macintosh laptop with OS 9.x or earlier:

You may need to set up your system to display on the projector screen as well as the LCD screen. Follow these steps:

1. From the Apple menu, select **Control Panels**, then click **Monitors** or **Monitors and Sound**.
2. Click the **Arrange** icon.

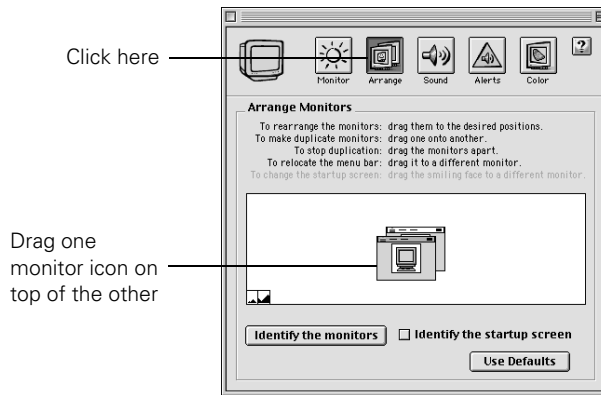

3. Drag one monitor icon on top of the other.

If the **Arrange** option isn't available, you may need to select one of the Simulscan resolution settings:

1. Click the **Monitor** icon, if necessary.

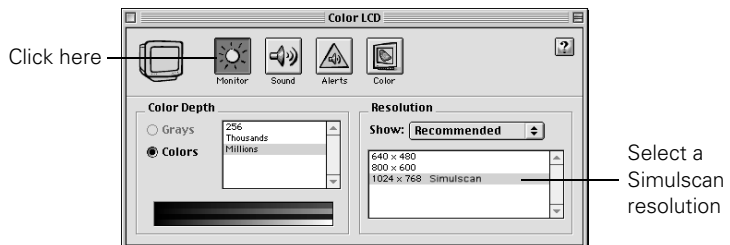

2. Select a **Simulscan** resolution as shown. (Allow a few seconds for the projector to sync up after making the selection.)

Adjusting the Image

Once you see your image, you'll need to make certain adjustments:

- To focus or zoom your image, see below.
- If the image is too high or too low, you can reposition it. See page 34.
- If the image isn't square, see page 35.
- To change the color mode for your image and surroundings, see page 36.
- If a computer image displays incorrectly, see page 37.

You can make many other adjustments to the image—such as changing the brightness, contrast, and aspect ratio—using the projector's menu system. See Chapter 4 for more information

Focusing and Zooming Your Image

Rotate the focus ring to sharpen the image.

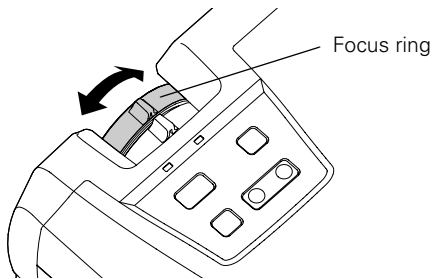

Rotate the zoom ring to reduce or enlarge the image.

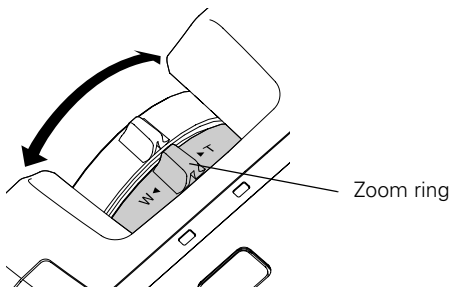

You can also change the image size by moving the projector closer to or farther away from the screen. You can use the **E-Zoom** buttons on the remote control to zoom in on a portion of the image. See page 42 for instructions.

Adjusting the Height of Your Image

If the image is too low, you can raise it by extending the projector's feet.

1. Stand behind the projector. Press the blue foot release levers on each side and lift the front of the projector. This unlocks the feet.

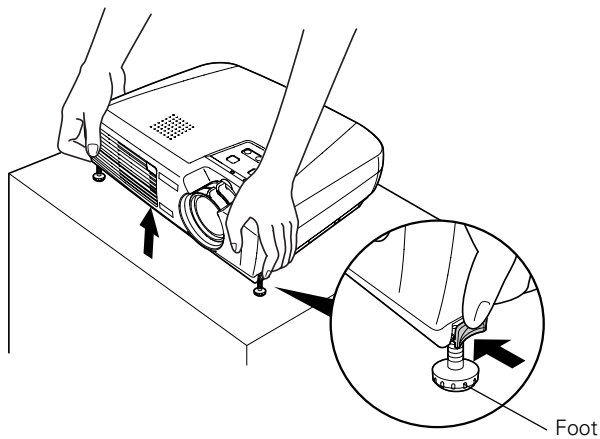





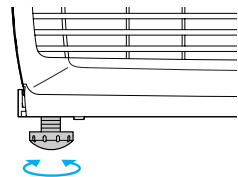

2. Once the image is positioned where you want, release the levers to lock the feet in position.
3. To fine-tune the height of the image, rotate the projector's feet.

If the image is no longer rectangular after raising it, see the next section.



Adjusting the Image Shape

The projector automatically corrects images that are distorted when the projector is tilted up or down (up to a 15° tilt). The Keystone feature appears on the screen while the projector makes the correction. If the projected image still isn't rectangular or has a "keystone" shape, do one or more of the following:

- If your image looks like  or , you've placed the projector off to one side of the screen, at an angle. Move it directly in front of the center of the screen, facing the screen squarely.
- If your image looks like  or , the Auto Keystone feature may have been disabled or you may need to manually adjust the keystone correction value. (Auto Keystone is not available when you're using ceiling or rear projection.) Follow the directions below:
 - To turn on Auto Keystone, press the **Menu** button on the remote control. Use the **▼** directional button to select the **Setting** menu, then press **Enter**. If **Auto Keystone** is **OFF**, press **▼** to highlight this option and press **Enter**. Select **ON** in the Auto Keystone window that appears and press **Enter** to save your changes. Exit the menu by pressing the **Menu** button.
 - To manually adjust the keystone correction value, press the  or  side of the **Keystone** button on the projector to correct the shape of the image. After correction, your image will be slightly smaller.

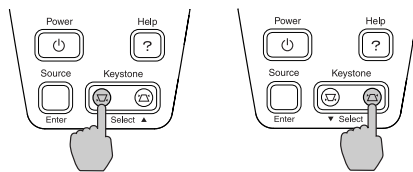
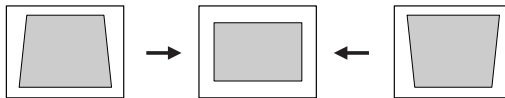

You can also make keystone adjustments using the projector's Setting menu. See page 52.

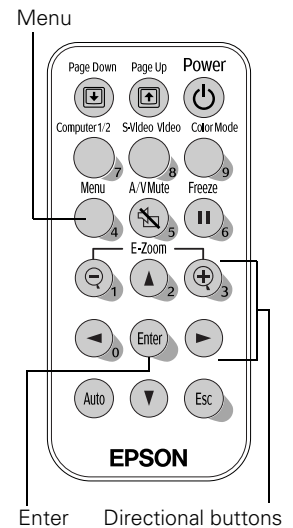

Adjusting the Brightness

The brightness of an image depends on the source you are projecting and the amount of light in the room. If the image is too bright or not bright enough, here are two ways you can adjust it:

- Change the **Brightness** setting in the Image menu. See page 49.
- Select **Low** or **High** for the **Brightness Control** option in the Advanced menu. (See page 54.) Low brightness mode extends the life of the lamp and decreases the fan noise.

Adjusting the Color Mode

You may want to adjust the color mode to select a different setting that is appropriate for the image you're projecting and the environment in which you're projecting it.

If you're projecting computer or RGB video images, the default color mode is **Presentation**, which is appropriate for presentations in bright rooms. For other images, the default color mode is **Dynamic**, which optimizes video images using natural colors.

The following table lists the 6 color modes available.

Color mode	Description
sRGB	Use when projecting computer images conforming to the sRGB color standard (the default setting when projecting from a computer with analog video)
Dynamic	Best for projecting movies with vivid color in bright rooms.
Presentation	Use when you're projecting a presentation in a bright room.
Theater	Use when projecting movies in a dark room.
Living Room	Best for playing video games or watching TV in a bright room.
Blackboard	Choose this fixed color mode when you need to project against a green blackboard.

To change the color mode, press the **Color Mode** button on the remote control until you see the mode you want. The currently selected setting appears in the upper right corner of the screen. You can also use the projector menu system to select the Color Mode in the Image menu (see page 49).

Correcting Computer Images

If you've connected a computer and the image doesn't look right, or it doesn't fit properly on the screen, press the **Auto** button on the remote control. This automatically resets the projector's tracking, sync, resolution, and position settings. You must be projecting an image for this button to have any effect. Additionally, if the **Auto Setup** option in the Image menu is set to **OFF**, the Auto function will not work. See page 50.

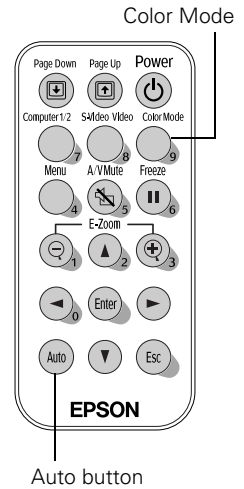

Shutting Down the Projector

When you've finished using the projector, follow the recommended procedure to shut it down. This extends the life of the lamp and protects the projector from possible overheating.

1. If you're using a computer, shut it down first; otherwise you may not be able to see your computer's display to shut it down properly.
2. To turn off the projector, press the **Power** button on the projector or remote control.

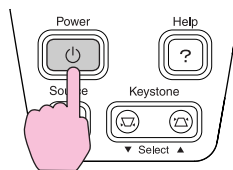
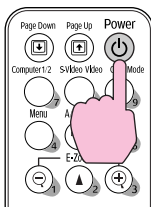

You see this confirmation message:
(If you don't want to turn it off, press any other button or wait a few seconds until it disappears.)

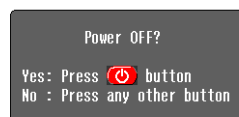



note

*When the projector has not received any input signals for 30 minutes, it automatically turns off the projector lamp and enters "sleep mode." This conserves electricity, cools the projector, and extends the life of the lamp. If you are done using the projector, unplug the power cord. If you want to start projecting again, press the **Power** button. You can turn Sleep mode on or off through the Setting menu. See page 53.*

caution

To avoid damaging the projector or lamp, never unplug the power cord when the power light is green or flashing orange.

3. Press the  Power button again. The lamp is turned off and the power light flashes orange for about 20 seconds as the projector cools down. When the projector has cooled, the light stays orange and the exhaust fan shuts off.

If you want to turn the projector on again, wait until the orange light stops flashing. Then press the  Power button.

4. Retract the front feet as shown.

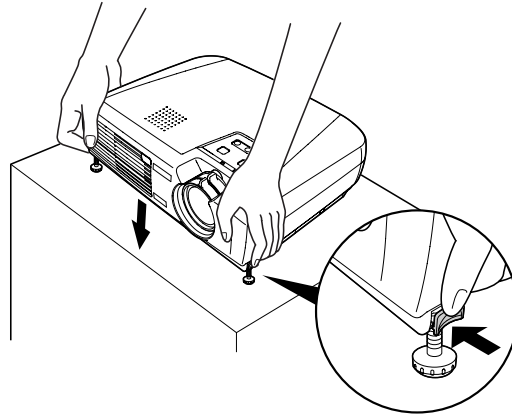

5. Replace the lens cap and unplug the power cord.
6. Turn off and disconnect any equipment plugged into the projector.
7. If you won't be using the projector for a while, store it in the soft case that came with it or in a protective case.

3 *Using the Remote Control*

The remote control lets you access your projector's features from anywhere in the room—up to 20 feet away. For example, you can turn the projector on and off, freeze the presentation, zoom in on a portion of your image, and access the menu system. (The projector menus let you adjust many projector settings; see Chapter 4.)

If you're using a computer and you've connected the mouse cable as described in Chapter 1, you can use the remote control as a wireless mouse.

When using the remote control, stand within 20 feet of the projector. Point the remote control either at the front or back of the projector or at the screen (the projector's front sensor can detect signals bounced off the screen). Press the button for the function you want to use.

This chapter covers the following information:

- Removing the battery tape
- Storing the remote control
- Controlling the picture and sound
- Using the remote control as a wireless mouse

Removing the Battery Tape

Before using the remote control, pull out the tape from the battery tray as shown below.

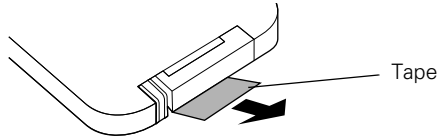

When the battery power runs low, you can replace it as described on page 44.

Storing the Remote Control

Most of the projector's features can be accessed only with the remote control. To prevent losing it, store it in the projector's remote control storage compartment when you are not using it.

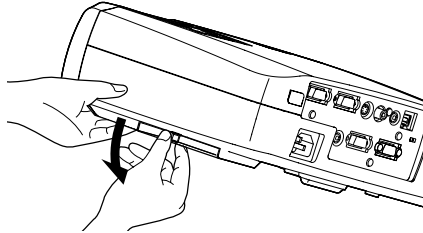

Open the door to the remote control tray

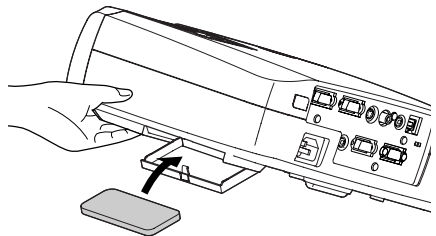

Then place the remote inside and close the door

Controlling the Picture and Sound

You can use the remote control to select your source, temporarily turn off the picture and sound, freeze the action, or zoom in on the picture. Make sure you have set up your projector and connected any equipment as described in Chapter 1.

Switching Between Picture Sources

If you've connected your projector to more than one computer and/or video source, you can use the buttons on the remote control to switch between the different sources.

- Press the **Computer1/2** button to select the computer or video source connected to the projector's **Computer1/Component Video1** or **Computer2/Component Video2** port.
- Press the **S-Video/Video** button to select an S-Video or standard composite video source.

After you select a source, the screen goes dark for a moment before the image appears. The name of the selected source (such as **Computer1** or **S-Video**) appears briefly on the screen.

Select the S-Video or Video source

Select the computer or RGB (component) video source

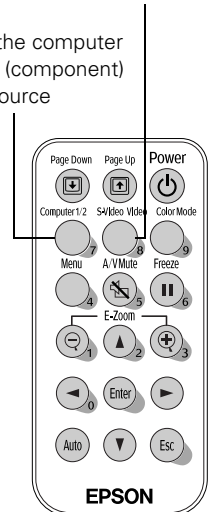

Turning Off the Picture and Sound

Press the **A/V Mute** button on the remote control to turn off the image and sound and darken your screen. This is useful if you want to temporarily re-direct your audience's attention without the distraction of a bright screen.

- To turn off the picture and sound, press the **A/V Mute** button. The screen goes dark.
- To turn the image and sound back on, press the button again or press **Esc**.

You can create an image, such as a company logo or a picture, to display on the screen whenever you press the **A/V Mute** button. See page 56 for more information.

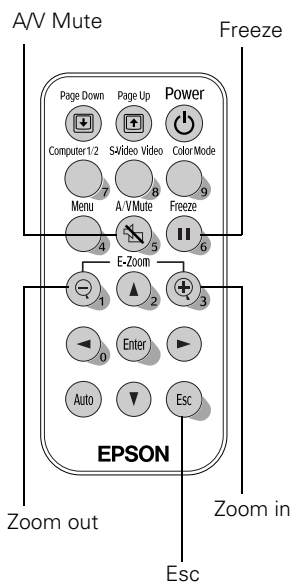

Stopping Action

Press the **Freeze** button to stop the action in your video or computer image and keep the current image on the screen. The sound will continue, however; and if you have connected an external monitor for simultaneous display, the action continues on the monitor even though it is paused on the screen.

Press the **Freeze** button again or press **Esc** to re-start it.

Zooming Your Image

Follow these steps to zoom in on a portion of the image:

1. Press the **E-Zoom** \oplus button on the remote control.
You see a crosshair indicating the center of the zoom-in area.
2. Use the directional buttons to position the crosshair in the area you want to enlarge.
3. Continue pressing the **E-Zoom** \oplus button to enlarge the selected area up to 4 times.

4. While the image is enlarged, you can:
 - Use the directional buttons to pan about.
 - Press the E-Zoom  button to zoom out.
5. When you're done, press the ESC button to return to the original size.

Using the Remote Control as a Wireless Mouse

When you use the remote control as a wireless mouse, you can control your computer or click through slideshow-style presentations (such as PowerPoint) from up to 20 feet away. This gives you more flexibility, since you don't need to stand near your computer to change slides.

To control your computer with the remote, make sure you have connected the mouse cable between the projector and your computer as described on page 19.

- To move the mouse pointer on the screen, aim the remote at the screen and use the directional buttons to move the cursor.
- To click (or left-click), press the **Enter** button.
- To right-click, press the **Esc** button.
- To double-click, press the **Enter** button twice.
- To click and drag, press down and hold the **Enter** button and use the directional buttons to move where you want to drag.
- To advance slides in a PowerPoint presentation in Slide Show mode, press the **Page up** or **Enter** button on the remote control. Press the **Page down** or **Esc** button to go back a slide.

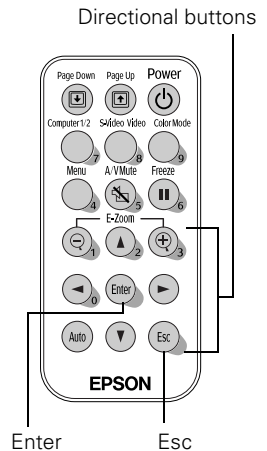

caution

When replacing batteries, take the following precautions:

- Replace the battery as soon as it runs out. If the battery leaks, wipe away battery fluid with a soft cloth. If fluid gets on your hands, wash them immediately.
- Do not expose batteries to heat or flame.
- Dispose of used batteries according to local regulations.
- Remove the battery if you won't be using the remote control for a long period of time.

Replacing the Battery

Follow these steps to replace the battery:

1. Press the tab towards the center of the remote and slide the battery tray out of the remote control.

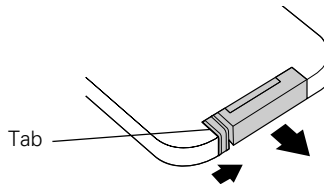

2. Remove the old battery and insert a CR2025 watch battery as shown.

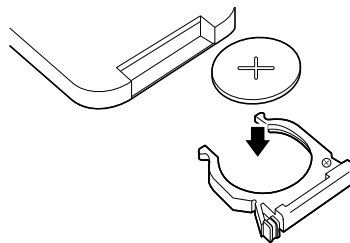

3. Slide the battery tray back into the remote until it clicks into place.

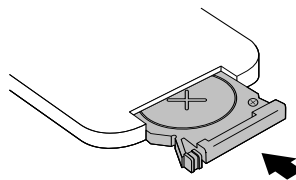

4

Fine-tuning the Projector

You can use the projector's remote control to access on-screen menus to adjust the image, sound, and other features. This chapter covers the following information:

- Using the menu system
- Adjusting the image
- Adjusting the sound
- Customizing projector features
- Viewing lamp usage and other information
- Creating your own screen logo
- Enabling password protection
- Restoring the default settings

Using the Projector's Menu System

The seven projector menus let you adjust and customize the projector features from the remote control:

- The Image menu controls the look and quality of the projected image. It lets you adjust the image position, select the color mode, and fine-tune settings such as Brightness, Sharpness, and Contrast.
- The Audio menu controls the volume level and audio input setting (**Audio1** or **Audio2**).
- The Setting menu allows you to adjust or enable features such as Keystone correction, background screen color, message display, and sleep mode.
- The User's Logo menu lets you capture and store a custom image or logo which you can then use as the startup screen or A/V Mute screen.
- The Advanced menu lets you select Low or High brightness mode, the menu language, startup screen, color setting, and rear or ceiling projection.
- The Info menu provides information about lamp status and computer or video settings.
- The Reset All menu lets you restore the projector's factory default settings.

Changing Menu Settings

Use the buttons on the remote control to access the menus and change settings. Follow these steps:

1. Press the **Menu** button on the remote control to display the menu screen:

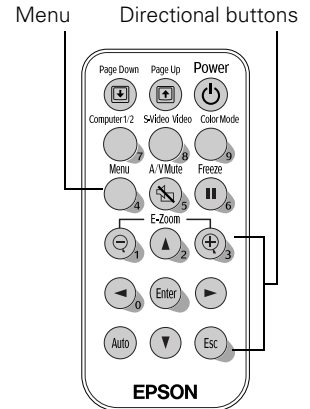
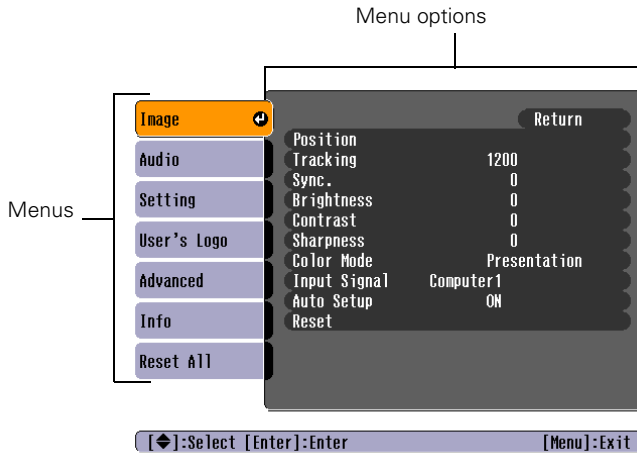

The seven menus are listed on the left, and the options available for the highlighted menu are shown on the right.

2. Press the up ▲ or down ▼ directional buttons to scroll through the menu list.
3. When the menu you want is highlighted, press the **Enter** button to select it. The highlight moves to the first option for that menu.
4. Use the directional buttons (▲, ▼, ◀, or ▶) to scroll through the list of options. (The options available depend on which source is selected.)
5. When the option you want to change is highlighted, press the **Enter** button to select it. Then use the directional buttons to change the setting.

The current setting is indicated by a green oval 0. Press the ▲ and ▼ buttons to select a different setting, and then press **Enter** to accept the new setting. The 0 for the new setting turns green.

note

*If you want to go back to the default settings on any menu, select **Reset**, press **Enter**, select **Yes**, and then press **Enter**.*

6. Press the **Esc** button to return to the previous menu or to close the menu system if you are at the main menu. Your changes are saved automatically.
7. Press the **Menu** button to exit the menu system.

Adjusting the Image

The Image menu lets you make adjustments to the projected image. The options available depend on which image source is selected:

Computer (Analog-RGB) RGB video



Video (Composite video, S-Video)

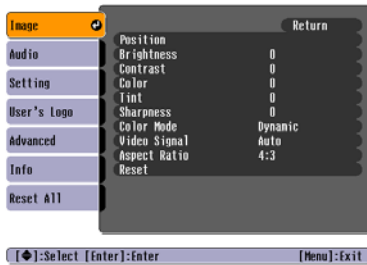

Component video (YCbCr, YPbPr)

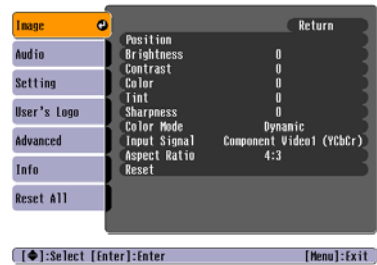

Follow these steps to adjust the appearance of your image:

1. Press the **Menu** button. You see the main menu.
2. Press **Enter** to select the Image menu.

3. Use the directional buttons and press **Enter** to select any of the following options:

■ **Position**

Press and hold one of the directional buttons to move the image on the screen left, right, up, or down.

■ **Tracking** (computer images only)

Removes unwanted vertical lines from a computer image by matching the projector's internal clock to various computer signals. See page 80 for more information about adjusting the tracking.

■ **Sync** (computer images only)

Corrects fuzziness or screen flicker by synchronizing the projector with the tracking signal sent from the computer. See page 80 for more information about adjusting the sync setting.

■ **Brightness**

Lightens or darkens the overall image.

■ **Contrast**

Adjusts the difference between light and dark areas.

■ **Color** (video only)

Adjusts the depth or intensity of the image.

■ **Tint** (video only)

Adjusts the balance of green to magenta in the image.

■ **Sharpness**

Sharpens or softens the image.

■ **Color Mode**

Corrects the vividness of image color. You can select from the following six settings, and save a different one for each computer and/or video source:

Dynamic: For projecting movies in vivid color in bright rooms

Presentation: For presentations in bright rooms

note

*If you have repositioned the image but then change your mind, you can press the **Auto** button on the remote control to restore the default settings.*

note

*You can also select **High Brightness** or **Low Brightness** mode in the **Advanced** menu. See page 54.*

Theatre: For optimizing movie images with natural color in a dark room (the default for video or S-Video display)

Living Room: For playing video games and watching TV in a bright room

sRGB: For standard sRGB computer displays (the default when projecting from a computer with analog video)

Blackboard: Fixed color mode when projecting against a green blackboard

note

Be sure to select the correct source with one of the Source buttons before you check the Input Signal.

- **Input Signal**

This setting should match the port to which your selected source is connected, such as **Computer1** when a computer is connected to the **Computer1/Component Video1**. When a component video source is connected, choose **YCbCr** or **YPbPr**, depending on the type of signals produced by your source. (You can tell which setting is correct by the quality of the projected image.)

- **Auto Setup** (computer images only)

Leave this setting **ON** to automatically optimize the computer image. Turn it off if you want to save adjustments you have made to the video settings.

- **Video Signal** (video only)

Leave this setting at **Auto** unless you are using a 60-Hz PAL system (select **PAL60**).

- **Aspect Ratio** (video only)

Set to **4:3** for letterbox video content and to **16:9** for widescreen video content.

4. When the image is set correctly, press **Esc** or **Menu**. Your settings are automatically saved.

Adjusting the Sound

You can use the Audio menu to adjust the sound volume and select the audio input port.

1. Press the **Menu** button. You see the main menu.
2. Select the Audio menu. You see the following:

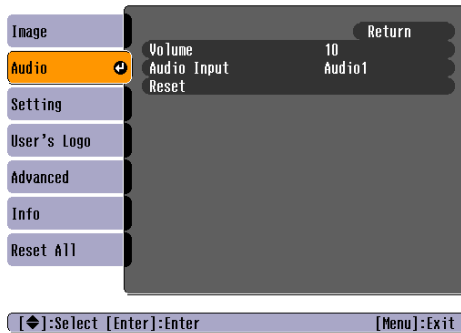

3. To increase or decrease the sound, select **Volume** and use the directional buttons to adjust it.
4. If you're using a different audio input port than the default port for your source, select **Audio Input** and then either **Audio 1** or **Audio 2**. Then press **Enter**.
5. When you're finished adjusting the audio settings, press **Esc** or **Menu**.

Customizing Projector Features

Use the Setting menu to disable the projector's sleep mode, adjust the image shape, and customize several other features.

1. Press the **Menu** button.
2. Select the **Setting** menu.

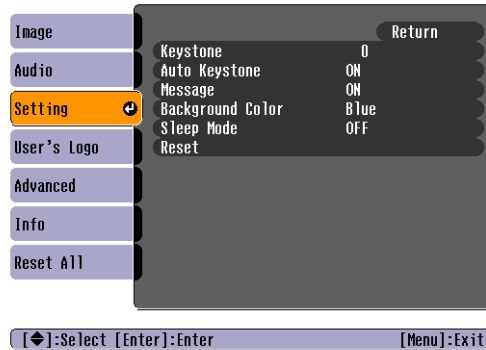

3. Press **Enter** and then use the directional buttons and the **Enter** button to set the following options:
 - **Keystone**
Adjusts a distorted image from a trapezoid shape to rectangular.
 - **Auto Keystone**
Automatically adjusts a distorted image from a trapezoid shape to rectangular when the projector's feet are extended or retracted. (Not available when you're projecting from the ceiling or using rear projection.) Select **ON** or **OFF**.
 - **Message**
Selects whether the projector displays a message in the following situations: when the image source is switched, or when no image signal is being received, when the color mode is changed, when an incompatible signal is input, and when the air filter needs to be changed.

- **Background Color**

Sets the screen background to Black, Blue, or Logo when the A/V Mute button is pressed. If the User's Logo Protect function has been set to ON, the Logo setting cannot be changed to Black or Blue. The Password Protect function must be cancelled first. See page 59.

- **Sleep Mode**

Enables or disables the power management system, which turns the lamp off when the projector has not received any input signals for 30 minutes.

4. When you're finished, press Esc or Menu.

Setting Advanced Features

Use the Advanced menu to change the brightness mode, configure the projector for rear projection and/or ceiling projection, and adjust other features.

1. Press the Menu button.
2. Select the Advanced menu. You see the features and their settings on the right side:

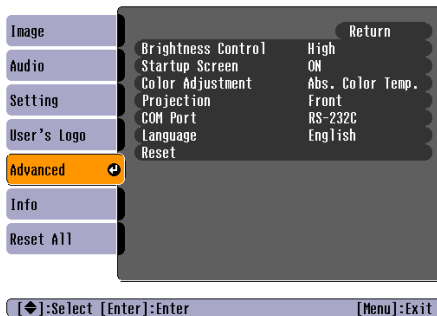

note

See page 56 for instructions on creating your own screen logo.

3. Press **Enter** and use the directional buttons and the **Enter** button to set the following options:

- **Brightness Control**

Select **Low** lamp brightness when the projection is too bright for the room. The **Low** setting also reduces the electricity consumption and fan noise. Select **High** to project the maximum brightness. (Also check the **Brightness** setting in the Image menu; see page 49.)

- **Startup Screen**

Turn on to display the image or logo you have captured whenever the projector is turned on. See page 56 for more information.

- **Color Adjustment**

Color Temp: Adjusts the whiteness of the screen.

RGB: Adjusts the individual RGB values.

- **Projection**

Front: Projector is in front of the screen

Front/Ceiling: Projector is in front of the screen, mounted upside-down from the ceiling

Rear: Projector is behind the screen

Rear/Ceiling: Projector is behind the screen, mounted upside-down from the ceiling

- **COM Port**

Turn on **USB** only if you're controlling the projector from a computer with the EMP Link 21L software. This software can be downloaded from the EPSON website at support.epson.com. (You must turn the projector off and then on again to use the new setting.)

- **Language**

Select from nine languages to be used for the projector menus.

4. When you're finished, press **Esc** or **Menu**.

note

The Startup Screen option cannot be turned off if the User's Logo Protect feature has been turned on. See page 59.

Viewing Lamp Usage and Other Information

Use the Info menu to view information about the display settings of your computer and the number of hours the lamp has been used.

1. Press the **Menu** button and select the **About** menu. You see the lamp usage hours and computer display settings on the right:

Computer (analog RGB, digital RGB, RGB Video/Component video, (YCbCr, YPbPr)



Video (Composite video, S-Video)



The life span of the lamp ranges from about 2000 hours in High brightness mode to about 3000 hours in Low brightness mode. If the number shown is close to 2000, make sure you have a spare lamp handy.

2. When you're finished, press **Esc** or **Menu**.

note

If you access the About menu when the projector display is set to video, you only see the lamp life, video source, and video signal settings.

note

The lamp usage timer doesn't register until you've used the lamp for at least 10 hours.

Creating Your Own Screen Logo

You can transfer any image on your computer to the projector, and then use it as the startup screen and/or the screen that is displayed when you press the **A/V Mute** button. The image can be a company logo, slogan, photograph, or any other image you want to use. The projector considers this image the “User’s Logo.”

Capturing the Image

Follow these steps to capture the image and transfer it to the projector:

1. Display the image you want to use on the projector. You can use an image from either a computer or video source such as a VCR or digital camera.
2. Press the **Menu** button and select the **User’s Logo** menu.

note

If the User’s Logo Protect function is ON, you see a message that the logo cannot be recorded. You’ll need to disable the User’s Logo Protect function before you can create or change the User’s Logo. See page 59.

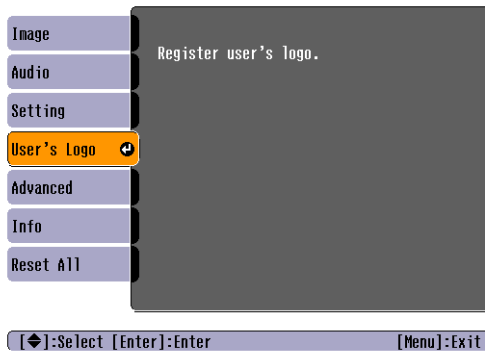

3. When you see a message asking if you want to use the present image as a user’s logo, Select **Yes** and press **Enter**. A selection box displays over the image.
4. Use the directional buttons to select the area of the image you want to use. Once you have selected the area, press **Enter**.
5. When you see the message “Select this image?” choose **Yes** and press **Enter**. If you want to change the area selected, select **No**, press **Enter** and repeat steps 4 through 6.

6. Use the directional buttons on the remote control to select a zoom rate (display size), and then press **Enter**.
7. When you see the message “Save image as user’s logo?,” select **Yes** and press **Enter**. Saving the logo takes few moments. Do not use the projector or other sources (computer, video, etc.) while the logo is being saved.
8. When you see the message “Completed,” press **Esc** or **Menu**.

Choosing When to Display the Screen Logo

After your screen logo is saved, you can set it up as the startup screen and/or the background screen, which is displayed when you press the **A/V Mute** button.

1. Press the **Menu** button to open the menu (if it is not already open).
2. To display the logo as the background screen when the **A/V Mute** button is pressed, select the **Setting** menu and press **Enter**. Select **Background Color**, choose **Logo**, and press **Enter**. Then press **Esc**.
3. To turn on the logo for your startup screen, select the **Advanced** menu and press **Enter**. Select **Startup Screen**, highlight **ON**, and press **Enter**.
4. When you’re finished, press **Esc** or **Menu**.

note

If the User’s Logo Protect function has been set to ON, the Logo setting cannot be changed from Logo to Black or Blue. You’ll need to turn the protect function off first. See page 59.

Enabling Password Protection

To prevent unauthorized use of the projector, you can assign it a password. If you do, a screen appears requesting the password whenever the projector is turned on. If you enter the password incorrectly three times in succession, the projector's operation is locked and you'll need to disconnect the power cord, then reconnect it to redisplay the password screen. If an incorrect password is entered nine times in a row, the projector is locked and you'll need to contact EPSON to unlock it. See "Where To Get Help" on page 83.

If you have created a user's logo for the projector (as described on page 56), you can also lock the logo on so it is displayed as the startup screen and/or AV/Mute screen. Unauthorized users cannot turn it off or change it. This feature is intended to discourage theft and provides a way to identify the projector should it be stolen.

Additionally, if someone else will be using the projector for a while but you want to make sure that person returns it by a certain time, you can temporarily disable the password for set period. When that time has elapsed, the password is reactivated and must be entered before the projector can be used.

Follow the instructions below to first set the password, and then turn on the password and/or user logo protection. Be sure to set the password before you turn it on; otherwise, you may lock yourself out of the projector.

note

If you should happen to enable the password before you set one, and you see the prompt to enter the password, enter the default password: 0000 to proceed.

Setting a Password

1. Press the Freeze button on the remote control for about 7 seconds, until you see the Password Protect menu:

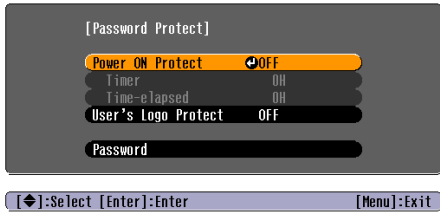

2. Select **Password** and press **Enter**. You see the message **Change the password?**
3. Select **Yes** and press **Enter**.
4. Enter a 4-digit password using the numeric keypad on the remote control.

The password will be displayed as ****. After you enter the last digit, a confirmation screen appears. Enter the password again.

5. After you finish setting the password, press the **Esc** button to return to the Password Protect menu.

Make a note of the password and keep it in a safe place in case you forget it.

Turning On the Password and User's Logo

1. To enable the password, select **Power ON Protect** and press **Enter**. Select **ON** then press **Esc**.
2. If you want to disable the password temporarily, select **Timer** and press **Enter**. Then use the numeric keypad to enter the number of hours (from 0 to 999) that you want the password feature disabled. If you want the projector to request the password every time it is turned on, set the timer to **0H**.

The countdown for the elapsed time begins as soon as you close the Password Protect menu. (You can check the elapsed time in this menu next to **Time elapsed**.)

note

If a password has already been set, you see the Password Protect Release screen. See "Starting the Projector with a Password" on page 60.

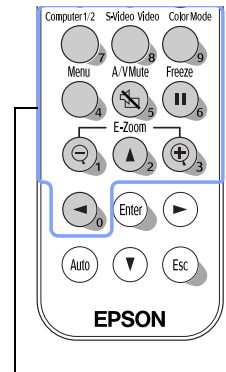

Use these buttons like a numeric keypad to enter the password

3. To enable your screen logo, select **User's Logo Protect** and press **Enter**. Select **ON** and press **Enter**.

When this feature is on the logo appears whenever the projector is turned on (if the Startup Screen is enabled) and as the A/V Mute screen (if you enabled the logo for the **Background Color** setting). None of the User's Logo features can be changed when the User's Logo Protect function is enabled.

4. Press **Menu** to close the Password Protect menu.

If you lose the remote control, you will not be able to enter the password; so keep the remote control in a safe place at all times. You can store it in the compartment under the projector. See "Storing the Remote Control" on page 40.

When the period defined in the Time-elapsed setting has passed, and the password is entered correctly, the elapsed time will be reset to 0 and the countdown will start again. So remember to disable or change this setting when you need to.

Starting the Projector with a Password

When the password function is enabled, you see this screen when you turn on the projector:



Use the numeric keypad buttons to enter the password that has been set. Once you have entered the password correctly, the password screen closes, and projection begins.

If the password is not correct, you see the message “Wrong password. Please try again.” If you enter an incorrect password three times in succession, you see the message “The projector’s operation will be locked. Request code xxxxx” and the projector switches to standby mode for approximately 5 minutes. Write down the request code. Then disconnect the projector’s power cord from the electrical outlet, reconnect it, and turn the projector back on.

When you see the Password Protect Release screen again, you can try to enter the correct password.

If you have forgotten the password, contact EPSON with the request code number that appears in the Password Protect Release screen for assistance. See “Where To Get Help” on page 83.

If you enter an incorrect password nine times in succession, the projector remains locked and you must contact EPSON to unlock it.

Restoring the Default Settings

The Reset All option lets you return the projector settings to their default values.

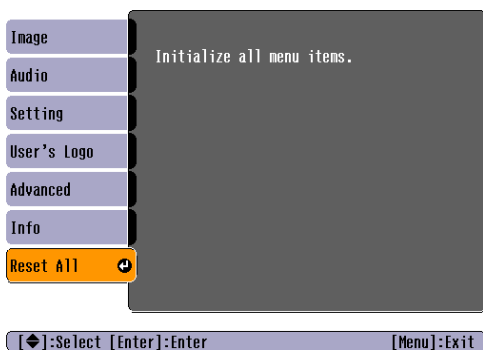

Select **Reset All** and press the **Enter** button on the remote control to display the confirmation screen. Select **Yes** to reset all the default settings or **No** to cancel.

note

The Input Signal, Video Signal, User's Logo, Lamp Hours, and Language settings do not return to their defaults when you select Reset All.

5

Maintaining and Transporting the Projector

Your projector needs little maintenance. All you need to do on a regular basis is keep the lens clean. Any dirt or smears on the lens may show up on your projected image.

warning

Before you clean any part of the projector, turn it off and unplug the power cord. Never open any cover on the projector, except the lamp and filter covers. Dangerous electrical voltages in the projector can injure you severely. Do not try to service this product yourself, except as specifically explained in this User's Guide. Refer all other servicing to qualified service personnel.

You also need to periodically clean the air filter on the bottom of the projector. A clogged air filter can block ventilation needed to cool the projector and cause overheating.

The only parts you should replace are the lamp and air filter. If any other part needs replacing, contact your dealer or a qualified servicer.

This chapter covers the following:

- Cleaning the lens
- Cleaning the projector case
- Cleaning and replacing the air filter
- Replacing the lamp
- Resetting the lamp timer
- Transporting the projector

Cleaning the Lens

Clean the lens whenever you notice dirt or dust on the surface.

- Use a canister of compressed air to remove dust.
- To remove dirt or smears on the lens, use lens-cleaning paper. If necessary, moisten a soft cloth with lens cleaner and gently wipe the lens surface.

caution

Do not use glass cleaner to clean the lens.

Cleaning the Projector Case

Before you clean the case, first turn off the projector and unplug the power cord.

- To remove dirt or dust, wipe the case with a soft, dry, lint-free cloth.
- To remove stubborn dirt or stains, moisten a soft cloth with water and a mild detergent. Then wipe the case.
- Do not use wax, alcohol, benzene, paint thinner, or other chemical detergents. These can damage the case.

Cleaning and Replacing the Air Filter

Clean the air filter on the bottom of the projector after every 100 hours of use. If it is not cleaned periodically, it can become clogged with dust, preventing proper ventilation. This can cause overheating and damage the projector. When the filter is clogged, the projector displays the message “The projector is overheated.”

To clean the air filter, follow these steps:

1. Turn off the projector, allow it to cool down, and unplug the power cord.
2. Turn the projector upside-down, as shown below.
3. To clean the filter, EPSON recommends using a small vacuum cleaner designed for computers and other office equipment. If you don't have one, gently clean the filter using a very soft brush (such as an artist's camel-hair brush).

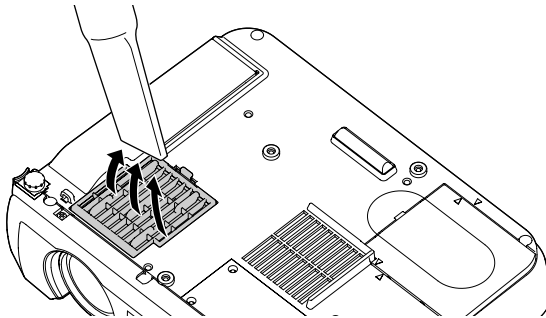

If the dirt is difficult to remove or if the filter is torn, replace it. Contact your dealer or call EPSON at (800) 873-7766 to obtain a new one. The air filter set (part number V13H134A05) contains five filters. In Canada, please call (800) 463-7766 to locate a dealer.

note

When you get a replacement lamp for your projector, a new air filter is included. You should replace the filter when you replace the lamp.

4. If you need to replace the filter, lift the tab on the filter cover and pull it upward to remove it.

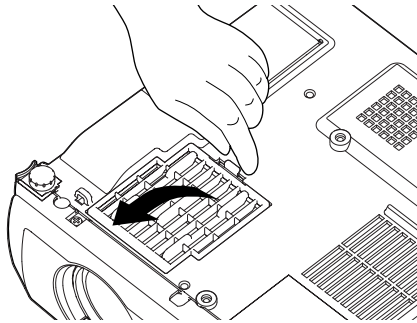

5. Remove the filter.
6. Install the new filter as shown below.

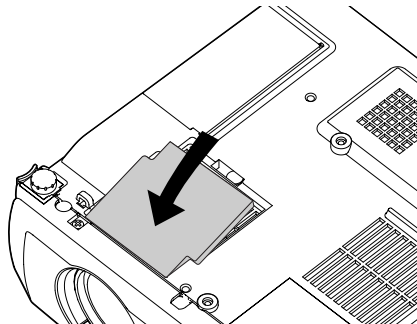

7. Replace the filter cover by inserting the tabs and then pressing down the other end until it clicks into place.

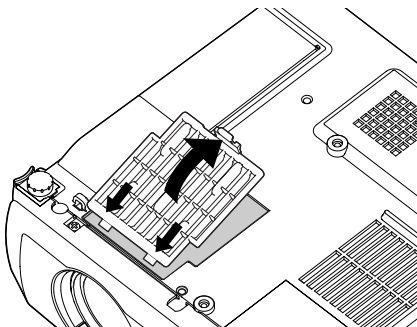

Replacing the Lamp

The projection lamp typically lasts for about 2000 hours of use (in High brightness mode) or 3000 hours (in Low brightness mode). It is time to replace the lamp when:

- The projected image gets darker or starts to deteriorate.
- The  warning light is flashing red at 0.5-second intervals.
- The message **Lamp Replace** appears on the screen when the lamp comes on. To maintain projector brightness and image quality, replace the lamp as soon as possible.

Contact your dealer or call EPSON at (800) 873-7766 in the United States for a replacement lamp. Request part number V13H010L27. In Canada, please call (800) 463-7766 to locate a dealer.

Follow these steps to replace the lamp:

1. Turn off the projector.
2. When the power light stops flashing and remains orange, unplug the power cord.
3. If the projector has been on, allow it to cool down for at least half an hour (or until the lamp is cool).
4. Turn the projector upside-down to access the lamp compartment.
5. Use the screwdriver included with the replacement lamp to slide the edge of the lamp cover towards the side of the projector. Then lift off the cover.

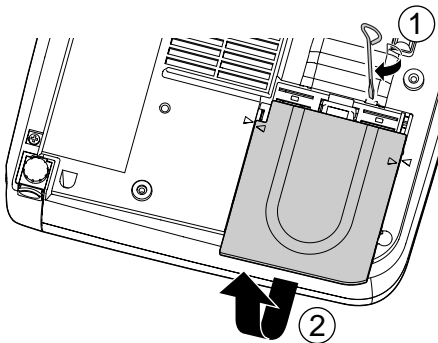

note

You can check to see how many hours the lamp has been used. See page 55.

warning

Let the lamp cool before replacing it. If the lamp breaks, handle the shards carefully to avoid injury.

6. Use the screwdriver to loosen the two screws holding the lamp in place. The screws are deep inside the projector on the sides of the lamp. (You can't remove the screws.)

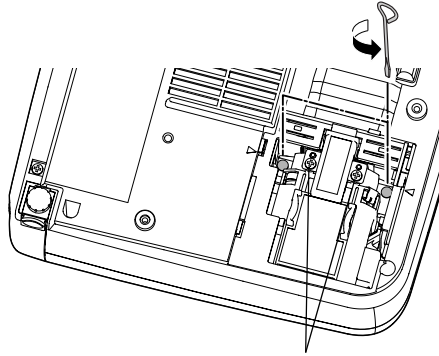

Don't remove these screws

warning

This product includes a lamp component that contains mercury. Please consult your state and local regulations regarding disposal or recycling. Do not put it in the trash.

7. Hold the lamp by the top, as shown, and pull it straight out.

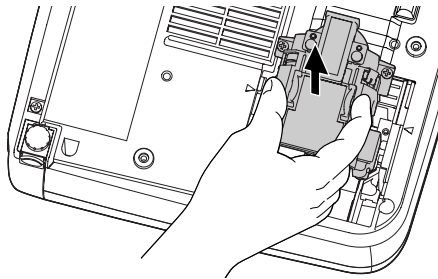

8. Gently insert the new lamp as shown below.

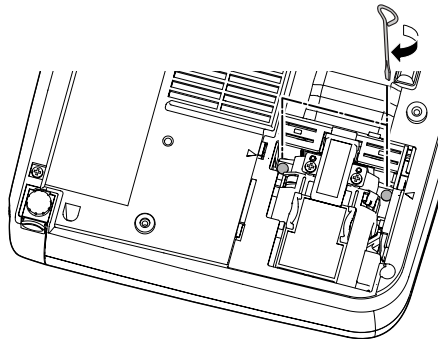

9. Once the lamp is fully inserted, tighten its screws.

- Position the lamp cover so the arrows on the lamp cover align with the arrows on the projector. Then slide in the cover until it clicks into place.

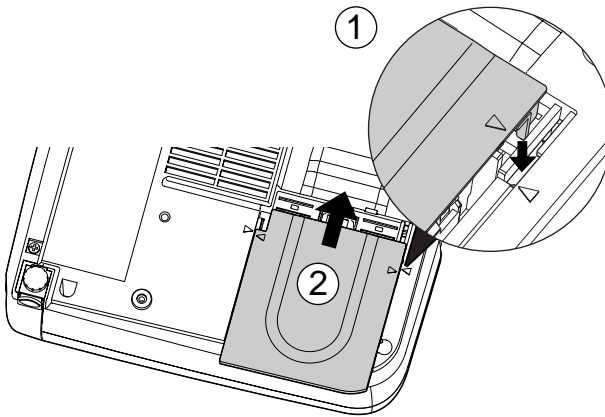

- Reset the lamp timer as described below.

Resetting the Lamp Timer

You must reset the lamp timer after replacing the lamp to clear the Lamp Replace warning message. Follow these steps:

- Connect the power cable and turn on the projector.
- Press the **Menu** button on the remote control and select the **Info** menu. Then press **Enter**. You see the following:

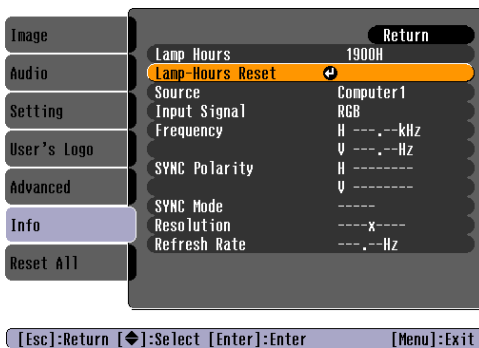

note

Do not reset the lamp timer if you have not replaced the lamp. If you do, the Lamp Hours will not accurately reflect the number of hours that the lamp has been used.

3. Press **Enter** to select the **Lamp-Hours Reset** option. You see the following:

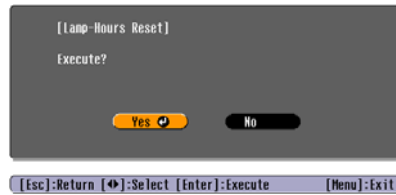

4. Select **Yes** and press **Enter**.
5. Press **Esc** to return to the main menu or the **Menu** button to exit the menu system.

Transporting the Projector

note

EPSON shall not be liable for any damages incurred during transportation.

The projector contains many glass and precision parts. If you need to transport it, please follow these packing guidelines to prevent damage to the projector:

- When shipping the projector for repairs, use the original packaging material if possible. If you do not have the original packaging, use equivalent materials, placing plenty of cushioning around the projector.
- When transporting the projector as freight or checked luggage, first put it in the supplied carrying case, then pack it in a firm box, using cushioning around the case.
- When you are hand-carrying the projector, be sure to use the supplied carrying case.

6 *Solving Problems*

This chapter helps you solve problems with your projector, and tells you how to contact technical support for problems you can't solve yourself. This chapter explains the following:

- Using the projector's on-screen help system
- What to do when the projector's status lights flash
- Solving problems with the image or sound
- Solving password problems
- Solving problems with the remote control
- Contacting technical support

Using On-Screen Help

If the image doesn't look right or your audio isn't working, you can get help by pressing the ? Help button on top of the projector. The following choices are available:

- Help for the image
- Help for the sound
- Language selection

Follow these steps to get help:

1. Press the ? Help button on the projector. You see the help menu.

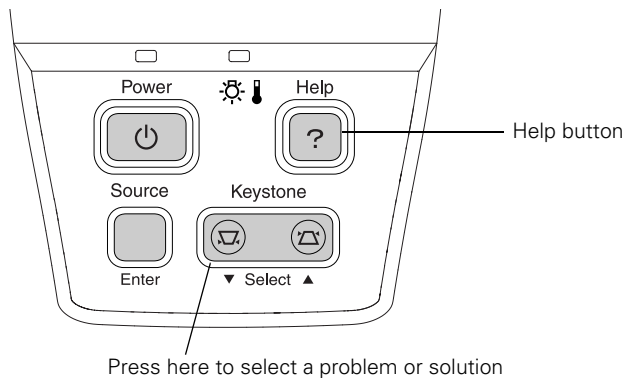

note

You can also use the directional buttons on the remote control to select Help options.

2. Press the left side of the **Select (Keystone)** button on the projector to highlight one of the options. Then press the **Enter (Source)** button on the projector to select it.
3. Press the left side of the **Select (Keystone)** button on the projector to highlight the problem you want to solve. Then press the **Enter (Source)** button to view the solution(s).

4. Highlight a solution (if this choice is available). Then press the **Enter (Source)** button to select the solution.

Highlight **Return** and press the **Enter (Source)** button if you need to back up.

If the solution is to adjust one of the settings, press the left side of the **Select (Keystone)** button on the projector to adjust it.

5. To exit the Help system, press the **? Help** button.

If none of the suggestions solves your problem, see additional solutions to problems in the following sections.

What To Do When the Lights Flash

The lights on top of the projector indicate the projector's status and let you know when a problem occurs.

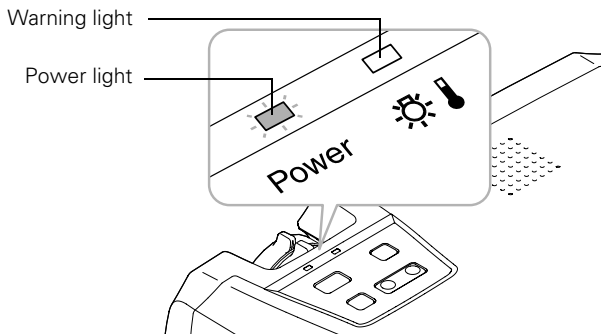

If the projector is not working correctly, first turn it off and unplug it. Then plug the power cord back in and turn on the projector. If this does not solve the problem, check the status lights on top of the projector and try the solutions recommended in the following table.

Power light	Warning light	Status	Description
—	Flashing red at 1-second intervals	Internal error	There is an internal error in the projector. Turn the projector off and unplug it. Contact EPSON for help.
—	Flashing red at 0.5-second intervals	Lamp failure	The lamp is burned out, broken, or not installed correctly; or the lamp cover is open. Close the cover or replace or reseal the lamp, if necessary, as described on page 67. If you need to replace the lamp, see page 67.
—	Red	Overheating	The projector has overheated and turned itself off. Let it cool for a few minutes, then turn it back on. Make sure there is plenty of space around and under the projector for ventilation. Also clean the air filter. See page 65. If it continues to overheat, you may need to replace the air filter.
—	Flashing orange (quickly)	High temperature warning	The projector is too hot. Make sure the temperature surrounding the projector does not exceed 95 °F (35 °C) and there is plenty of space around and under the projector for ventilation. Clean the air filter, if necessary. See page 65 for instructions.
Orange	Off	Standby (sleep) mode	The projector is in standby or sleep mode. You can unplug it or press the  Power button to turn it on.
Flashing green	Off	Warming up	The projector is warming up. Wait for the image to appear.
Green	Off	Operating	The projector is operating normally.
Flashing orange	Off	Cooling down	The projector is cooling down. Wait for the light to stay lit orange without flashing before unplugging it.

Solving Problems with the Image or Sound

No image appears on the screen.

- Check that the power light is green, not flashing, and the lens cap is off.
- The projector may be in standby or sleep mode. If the projector has not received any input signal for 30 minutes, it turns off the lamp to conserve the lamp life and save energy. If the power light is orange, press the **⏻ Power** button to turn the projector on.
- Press the **A/V Mute** button to make sure the picture has not been turned off temporarily.
- If the power was switched off and then on again, the projector may still be cooling down. Wait until the power light stops flashing and remains orange; then press the **⏻ Power** button again.
- Check the **Video Signal** or **Input Signal** setting in the Image menu to make sure it is correct for the selected source. See page 50 for more information.
- Has the **Message** option in the Setting menu been set to **OFF**?
- Adjust the **Brightness** setting on the Image menu or select **High** for the **Brightness Control** setting in the Advanced menu. See page 49 or page 54.
- The attached computer may be in sleep mode or displaying a black screen saver. Try pressing a key on the computer.

Nothing appears on the external monitor.

- Make sure the VGA computer cable is connected to your computer's video port and the projector's Computer1/Component Video1 port. It will not work if you connected the computer cable to the projector's Computer2/Component Video2 port.
- Make sure the cable from your monitor is connected to the projector's Monitor Out port.

You see a blue screen with the message No Signal displayed.

- Make sure the cables are connected correctly, as described in Chapter 1.
- Make sure the power to your computer or video source is turned on.
- If you've connected a computer and one or more video sources, you may need to press the **Source** button (on the projector) or the **Computer1/2** or **S-Video/Video** button (on the remote control) to select the correct source. Allow a few seconds for the projector to sync up after pressing the button.
- If you've connected a laptop computer, make sure it's set to display on an external monitor. See page 31.

If you're using a PC laptop:

- Hold down the Fn key and press the function key that lets you display on an external monitor. It may have an icon such as , or it may be labelled **CRT/LCD**. Allow a few seconds for the projector to sync up after pressing it. Check your laptop's manual or online help for details.

On most systems, the  or **CRT/LCD** key lets you toggle between the LCD screen and the projector, or display on both at the same time.

- Depending on your computer's video card, you might need to use the Display utility in the Control Panel to make sure that both the LCD screen and external monitor port are enabled. See your computer's documentation or online help for details.

If you're using a PowerBook or iBook with Macintosh OS X:

1. From the Apple menu, select **System Preferences**, then click **Display**.
2. Select **VGA Display** or **Color LCD**, click **Arrange** or **Arrangement**, then put a check mark in **Mirror Displays**.

If you're using a PowerBook or iBook with Macintosh OS 9.x:

1. From the Apple menu, select **Control Panels**, then click **Monitors** or **Monitors and Sound**.
2. Click the **Arrange** icon.
3. Drag one monitor icon on top of the other. This lets you display on the projector screen as well as the LCD screen.
4. If the **Arrange** icon isn't available, click the **Monitor** icon.
5. Select one of the listed **Simulscan** resolutions. (Allow a few seconds for the projector to sync up after making the selection.)

The message Not Supported is displayed.



- Make sure your computer's resolution doesn't exceed UXGA and the frequency is supported by the projector. See page 88. If necessary, change your computer's resolution setting as described below.
- Make sure the correct **Video Signal** is selected in the **Image** menu. See page 50. It should normally be set to **Auto**.

Only part of the computer image is displayed.

- You may need to adjust the **Position** setting in the Image menu. See page 49 for more information.
- If you changed the Aspect Ratio setting for a different source, you may need to change it back to 4:3. See page 50 for instructions.
- Make sure your computer's resolution setting is correct. Ideally, it should be 1024 × 768 (for the PowerLite 74c) or 800 × 600 (for the PowerLite 54c) to match the projector's native resolution. If this option isn't available, select one of the other compatible video formats listed on page 88.
 - **Windows:**
Right-click the desktop, select **Properties**, click the **Settings** tab, and select a different resolution.
 - **Macintosh OS X:**
On the Apple menu, choose **System Preferences**, then click **Display**. Select a different resolution.
 - **Macintosh OS 9.x:**
On the Apple menu, choose **Control Panels**, then click **Monitors** or **Monitors and Sound**. Select a different resolution.
- You also may need to modify existing presentation files if you created them for a different resolution. See your software documentation for specific information.
- If you used the E-Zoom feature, press **Esc** on the remote control to cancel zooming and return to full screen size.

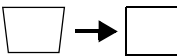
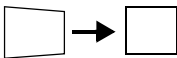
The image isn't rectangular, but trapezoid-shaped.



- Make sure the projector isn't placed off to one side of the screen, at an angle, or the image won't be rectangular. Place it directly in front of the center of the screen, facing the screen squarely.
- If you've tilted the projector upward, the image will be broader at the top. Turn on Auto Keystone correction as described on page 52 or hold down the  or  side of the **Keystone** button on top of the projector until the image is rectangular.

The image contains static or noise.

- If you're using a computer cable longer than 6 feet, or an extension cable, the image quality may be reduced.
- Keep your computer and video cables separated from the power cord as much as possible to prevent interference.
- The video signal may be split between the computer and the projector. If you notice a decline in the projected image quality when the image is displayed simultaneously on your laptop computer and the projector, turn off the laptop's LCD display.
- Check the **Input Signal** or **Video Signal** setting in the Image menu.
- Make sure the cables are securely connected.
- Select the correct resolution; see "Compatible Video Formats" on page 88.
- Try adjusting the **Sync** and **Tracking** settings in the Image menu.

The image is blurry.

- Adjust the focus using the focus ring.
- Make sure the lens cap is off.
- There may be dirt or smears on the lens. Clean the lens as described on page 64.
- Make sure the lens is not fogged by condensation. You may need to wait before using the projector after moving it from a cold environment.
- Make sure the projection distance is within the range described on page 14.
- Adjust the **Sharpness** setting on the Image menu (see page 49). You should be able to see the effect on the screen immediately. If you're projecting from a computer, you may also need to adjust the **Tracking** and **Sync** as described in the next section. If you don't like the new settings, you can always select **Reset** to return to the factory default settings.

You see vertical stripes or the image still looks blurry after trying the solutions in the previous section.

- If you're projecting from a computer and displaying an image that contains a lot of fine detail, you may notice one or more vertical stripes or bands, or some of the characters may look heavy or blurred. Press the **Auto** button on the remote control. This resets the projector's tracking and sync settings.
- If further adjustment is needed, you can fine-tune the **Tracking** and **Sync** settings manually using the **Image** menu as described on page 49.
 1. Fill the screen with an image containing fine detail when making these adjustments. For example, in Windows you can select a pattern to appear as your desktop background. Or try projecting black text on a white background.
 2. Adjust the **Tracking** to eliminate vertical stripes.
 3. Adjust the **Sync** to increase the sharpness of the image.



The colors of the image are not right.

- Try selecting a different **Color Mode**.
- If you're displaying video, adjust the **Color** and **Tint** settings on the **Image** menu. See page 48 for instructions.
- Adjust the **Brightness** and **Contrast** settings on the **Image** menu.
- Try adjusting the **Color Adjustment** setting on the **Advanced** menu.
- If the images appear too green or too purple, check that the **Input Signal** or **Video Input** setting is correct on the **Image** menu.
- Check your computer display settings to correct the color balance.
- If the image seems dark, the lamp may be nearing time for replacement. Check the lamp hours as described on page 55 and replace it, if necessary, as described on page 67.

note

Because of the different technologies used, your projected image may not exactly match the colors on your laptop or computer monitor.

There is no sound.

- Try turning up the volume in the Audio menu (see page 51).
- Make sure the **A/V Mute** function is not on.
- If you're using a VCR or other video source, make sure its volume is not turned all the way down or muted. Also, make sure the cables are connected correctly, as described in Chapter 1.
- Make sure the audio cable is connected to the correct Audio port. See page 20 or page 23.
- If your presentation includes computer audio, make sure the volume control on your computer is not turned all the way down or muted. Make sure the audio cable is securely connected to both the projector and your computer's  headphone jack or  audio out jack. See page 20.
- Make sure the Windows volume controls on your computer are not turned all the way down or set to Mute. Check this by clicking the volume control in your Windows System Tray (lower right corner of the screen).
- The wrong source may be selected. Press the **Source** button on the projector—or the **Computer1/2** or **S-Video/Video** button on the remote control—to select the correct source.
- Check the **Audio Input** setting in the Audio menu.

Solving Password Problems

You have forgotten the password.

- Write down the request code that appears in the Password Protect Release screen and contact EPSON. See “Where To Get Help” on page 83.
- If you turned on the password protect feature before setting the password and no password was set before, try using the default password: 0000.

You don't have the remote control.

You must have the remote control to enter the password. If necessary, you can purchase a replacement remote control from EPSON (part number: V12H007T13).

Solving Problems with the Remote Control

The projector doesn't respond to remote control commands.

- Make sure the tape has been removed from the battery tray as described on page 40.
- Make sure you are within 20 feet of the projector, and within range of the projector's front or back sensor (approximately 30° to the left or right and 15° above or below).
- The remote control battery may not be installed correctly or may be low on power. Change the battery as described on page 44.
- Dim the room lights and turn off any fluorescents. Make sure the projector is not in direct sunlight. Strong lighting, especially fluorescent lights, may affect the projector's infrared receivers.
- Turn off any nearby equipment that emits infrared energy, such as a radiant room heater.

You have lost the remote control.

You need the remote control to access many projector features. If you have lost it, you can order another from EPSON (part number V12H007T13).

To prevent losing the remote control, store it in the compartment beneath the projector, as described on page 40.

You can't control the mouse pointer with the remote control.

- Make sure the mouse cable is securely connected to both your computer's mouse port or USB port and the projector's USB port. For details, see page 19.
- Make sure **RS232C** is selected as the COM Port setting in the Advanced menu. See page 54.
- To use the USB mouse connection on a PC, your system must have a "clean" installation of Windows 98, Windows Me, Windows XP, or Windows 2000. The connection may not work correctly if your system was upgraded from Windows 95.

Where To Get Help

EPSON provides technical assistance through electronic support services 24 hours a day, as listed in the following table.

Service	Access
World Wide Web	From the Internet, you can reach EPSON's product support page at http://support.epson.com . After selecting your product, you can access troubleshooting information, download product documentation, and receive technical advice through e-mail.
Presenters Online	Access tips, templates, and training for developing successful presentations at http://www.presentersonline.com

Telephone Support Services

To use the EPSON PrivateLine Support service, call (800) 637-7661 and enter the PIN on the EPSON PrivateLine Support card included in your Start Here kit. This is the fastest way of speaking to a live representative, and it's free. This service is available 6 AM to 6 PM, Pacific Time, Monday through Friday, for the duration of your warranty period.

You may also speak with a projector support specialist by dialing one of these numbers:

- U.S.: (562) 276-4394, 6 AM to 6 PM, Pacific Time, Monday through Friday
- Canada: (905) 709-3839, 6 AM to 6 PM, Pacific Time, Monday through Friday

Toll or long distance charges may apply.

Before you call, please have the following information ready:

- Product name (EPSON PowerLite 54c or PowerLite 74c)
- Product serial number (located on the bottom of the projector)
- Computer or video configuration
- Description of the problem

You can purchase screens, carrying cases, or other accessories from EPSON at (800) 873-7766 or by visiting the EPSON Store at www.epsonstore.com (U.S. sales only). In Canada, please call (800) 463-7766 for dealer referral.

A

Appendix A: Technical Specifications

General

Type of display	Poly-silicon TFT active matrix
LCD panels (3)	Diagonal size: 0.7 inches (17.8 mm)
Lens	F=1.70 to 1.87, f=21.3 to 25.6 mm
Resolution	74c: 1024 × 768 pixels 54c: 800 × 600 pixels
Color reproduction	Full color, 16.8 million colors
Brightness (ANSI)	2000 lumens (High brightness mode) 1500 lumens (Low brightness mode)
Contrast ratio	500:1
Image size	30 to 300 inches (0.8 to 7.6 meters)
Projection distance	2.9 to 34.4 feet (0.9 to 10.5 meters)
Projection methods	Front, rear, ceiling
Focus adjustment	Manual
Zoom adjustment	Manual
Internal sound system	1 W monaural
Optical aspect ratio	4:3 (horizontal : vertical)
Zoom ratio	1:1.2
Noise level	38 dB (High brightness mode) 33 dB (Low brightness mode)
Keystone correction angle	±15° vertical (maximum)



Pixelworks DNX™ ICs are used in this projector.

Projection Lamp

Power consumption	200 W
Lamp life	About 2000 hours (High brightness); 3000 hours (Low brightness)
Part number	V13H010L27

Remote Control

Range	20 feet (6 meters)
Battery	CR2025 lithium

Mouse Compatibility

Supports USB

Dimensions

Height	3.4 to 3.8 inches (feet extended) (87 to 97 mm)
Width	12.4 inches (315 mm)
Depth	9.5 inches (240 mm)
Weight	6.4 lb (2.9 kg)

Electrical

Rated frequency	50/60 Hz
Power supply	100 to 120 VAC, 2.6 A 200 to 240 VAC, 1.3 A
Power consumption	Operating: 280 W Standby: 3 W

Environmental

Temperature	Operating: 41 to 95 °F (5 to 35 °C) Storage: 14 to 140 °F (–10 to 60 °C)
Humidity	Operating: 20 to 80% RH, non-condensing Storage: 10 to 90% RH, non-condensing

Safety and Approvals

United States	FCC 47CFR Part15B Class B (DoC) UL1950 Rev. 3
Canada	ICES-003 Class B CSA C22.2 No. 950-95 (cUL)
CE Marking	Directive 73/23/EEC, 89/336/EEC EN 55022, EN 55024

Compatible Video Formats

The projector supports NTSC, PAL, and SECAM international video standards, as well as the monitor and HDTV display formats listed below.

To project images output from a computer, the computer's video card must be set at a refresh rate (vertical frequency) that's compatible with the projector; see the following table for compatible formats. As noted below, some images are automatically resized to display in one of the projector's "native" formats (such as XGA). In addition, the frequencies of some computers may not allow images to display correctly; see your computer's documentation for details.

Mode	Refresh Rate (Hz)	Resolution
VGAEGA	70	640 × 350*
VGA—60	60	640 × 480*
VESA—72	72	640 × 480*
VESA—75	75	640 × 480*
VESA—85	85	640 × 480*
SVGA—56	56	800 × 600* ¹
SVGA—60	60	800 × 600* ¹
SVGA—72	72	800 × 600* ¹
SVGA—75	75	800 × 600* ¹
SVGA—85	85	800 × 600* ¹
XGA—43i	43	1024 × 768* ²
XGA—60	60	1024 × 768* ²
XGA—70	70	1024 × 768* ²
XGA—75	75	1024 × 768* ²
XGA—85	85	1024 × 768* ²
SXGA1—70	70	1152 × 864*
SXGA1—75	75	1152 × 864*
SXGA1—85	85	1152 × 864*
SXGA2—60	60	1280 × 960*
SXGA2—75	75	1280 × 960*
SXGA2—85	85	1280 × 960*
SXGA3—43i	43	1280 × 1024*
SXGA3—60	60	1280 × 1024*
SXGA3—75	75	1280 × 1024*
SXGA3—85	85	1280 × 1024*

Mode	Refresh Rate (Hz)	Resolution
UXGA—48i	48	1600 × 1200* ³
UXGA—60	60	1600 × 1200* ³
MAC13	67	640 × 480*
MAC16	75	832 × 624*
MAC19—60	59	1024 × 768* ²
MAC19	75	1024 × 768* ²
MAC21	75	1152 × 870*
NTSC	60	—
NTSC 4:3	60	—
PAL	50	—
M-PAL	60	—
N-PAL	50	—
PAL—60	60	—
SECAM	50	—
HDTV (480i)	59.94	720 × 480*
HDTV (480p)	59.94	720 × 480*
HDTV (575i)	50	720 × 574*
HDTV (575p)	50	720 × 574*
HDTV (720p)	60	1280 × 720*
HDTV (1080i)	60	1920 × 1080*
HDTV (1080i) 33.75/ 31.25	50	1920 × 1080*

* The image is resized using EPSON's SizeWise Technology.

¹ Resized on the PowerLite 74c only; native mode on the PowerLite 54c.

² Resized on the PowerLite 54c only; native mode on the PowerLite 74c.

³ Resized on the PowerLite 74c only; not available on the PowerLite 54c.

Computer Video Port Pin Assignments

The Computer port is a female video RGB, 15-pin micro-D-style connector. Here are its pin assignments:

Pin no.	Computer port
1	Red video
2	Green video
3	Blue video
4	GND
5	GND
6	Red GND
7	Green GND
8	Blue GND
9	Reserved
10	Synchronous GND
11	GND
12	SDA
13	Horizontal sync / composite sync
14	Vertical sync
15	SCL

B

Appendix B: Notices

This appendix includes safety instructions and other important information about your EPSON PowerLite 54c/74c.

Important Safety Instructions

Follow these safety instructions when setting up and using the projector:

- Do not place the projector on an unstable cart, stand, or table.
- Do not use the projector near water or sources of heat.
- Use attachments only as recommended.
- Use the type of power source indicated on the projector. If you are not sure of the power available, consult your dealer or power company.
- Place the projector near a wall outlet where the plug can be easily unplugged.

Placez le projecteur près d'une prise de contact où la fiche peut être débranchée facilement.

- Insert the projector's two-wire plug into an electrical outlet. Do not hold the plug with wet hands.
- Take the following precautions for the plug. Failure to comply with these precautions could result in sparks or fire: Do not insert the plug into an outlet with dust present. Insert the plug firmly into the outlet.
- Do not overload wall outlets, extension cords, or integral convenience receptacles. This can cause fire or electric shock.
- Do not place the projector where the cord can be walked on. This may result in fraying or damage to the plug.
- Unplug the projector from the wall outlet before cleaning. Use a damp cloth for cleaning. Do not use liquid or aerosol cleaners.
- Do not block the slots and openings in the projector case. They provide ventilation and prevent the projector from overheating. Do not operate the projector on a sofa, rug, or other soft surface, or in a closed-in cabinet unless proper ventilation is provided.

- Never push objects of any kind through cabinet slots. Never spill liquid of any kind into the projector.
- Except as specifically explained in this *User's Guide*, do not attempt to service this product yourself. Refer all servicing to qualified service personnel. Opening or removing covers may expose you to dangerous voltages and other hazards.
- This product includes a lamp component that contains mercury. Please consult your state and local regulations regarding disposal or recycling. Do not put it in the trash.
- Unplug the projector during lightning storms or when it will not be used for extended periods.
- Do not place the projector and remote control on top of heat-producing equipment or in a hot location.
- Unplug the projector from the wall outlet and refer servicing to qualified service personnel under the following conditions: When the power cord or plug is damaged or frayed. If liquid has been spilled into the projector, or if it has been exposed to rain or water. If it does not operate normally when you follow the operating instructions, or if it exhibits a distinct change in performance, indicating a need for service. If it has been dropped or the housing has been damaged.
- If you use the projector in a country other than where you purchased it, use the correct power cord for that country.
- Do not stand on the projector or place heavy objects on it.
- Do not attempt to remove the lamp immediately after use. Allow the lamp to cool for approximately one hour before removing it.
- Do not use the projector outside of the required temperature range: 41 to 95 °F (5 to 35 °C). Doing so may cause an unstable display and an excessive load on the fan, leading to projector damage.
- Do not store the projector outside of the required temperature range—14 to 140 °F (–10 to 60 °C)—or in direct sunlight for long periods of time. Doing so may cause damage to the case.
- Do not use the projector with the lens cap in place. The heat generated by the lamp may damage the cap.
- The liquid crystal display panel contains more than 99.99% active pixels. However, 0.01% of the pixels may be missing or constantly illuminated.

Remote Control Information

You can operate the projector by remote control via a line-of-sight infrared (IR) receiver at the front and rear of the projector. The projector may not respond to remote control commands under the following conditions:

- There is an object between the remote control IR emitter and the IR receiver on the projector.
- Ambient light is too bright.
- Certain types of fluorescent lighting are used.
- A strong light source shines into the IR receiver.
- Other equipment that emits infrared energy, such as a radiant room heater, is in the room.

These conditions commonly cause problems for most infrared-controlled equipment. Try the following:

- The remote control unit's battery may be low on power; replace it.
- Dim the ambient lighting and/or turn off any fluorescent lights.
- Close any window coverings and/or move the projector out of direct sunlight.
- Turn off other equipment that emits infrared energy.

If the remote control still does not work correctly, you can always run your computer-based presentation directly from the computer.

Declaration of Conformity

According to 47CFR, Part 2 and 15 Class B Personal Computers and Peripherals; and/or CPU Boards and Power Supplies used with Class B Personal Computers:

We: Epson America, Inc.
Located at: 3840 Kilroy Airport Way
MS: 3-13
Long Beach, CA 90806
Tel: (562) 290-5254

Declare under sole responsibility that the product identified herein, complies with 47CFR Part 2 and 15 of the FCC rules as a Class B digital device. Each product marketed, is identical to the representative unit tested and found to be compliant with the standards. Records maintained continue to reflect the equipment being produced can be expected to be within the variation accepted, due to quantity production and testing on a statistical basis as required by 47CFR §2.909. Operation is subject to the following two conditions: (1) this device may not cause harmful interference, and (2) this device must accept any interference received, including interference that may cause undesired operation.

Trade Name: EPSON
Type of Product: Projector
Model: EMP-54/74
Marketing name: PowerLite-54c/PowerLite-74c

FCC Compliance Statement

For United States Users

This equipment has been tested and found to comply with the limits for a Class B digital device, pursuant to Part 15 of the FCC Rules. These limits are designed to provide reasonable protection against harmful interference in a residential installation. This equipment generates, uses, and can radiate radio frequency energy and, if not installed and used in accordance with the instructions, may cause harmful interference to radio or television reception. However, there is no guarantee that interference will not occur in a particular installation. If this equipment does cause interference to radio and television reception, which can be determined by turning the equipment off and on, the user is encouraged to try to correct the interference by one or more of the following measures:

- Reorient or relocate the receiving antenna.
- Increase the separation between the equipment and receiver.
- Connect the equipment into an outlet on a circuit different from that to which the receiver is connected.
- Consult the dealer or an experienced radio/TV technician for help.

WARNING

The connection of a non-shielded equipment interface cable to this equipment will invalidate the FCC Certification of this device and may cause interference levels which exceed the limits established by the FCC for this equipment. It is the responsibility of the user to obtain and use a shielded equipment interface cable with this device. If this equipment has more than one interface connector, do not leave cables connected to unused interfaces. Changes or modifications not expressly approved by the manufacturer could void the user's authority to operate the equipment.

For Canadian Users

This Class B digital apparatus meets all requirements of the Canadian Interference-Causing Equipment Regulations.

Cet appareil numérique de la classe B respecte toutes les exigences du Règlement sur le matériel brouilleur du Canada.

Warranty

Epson America, Inc. Limited Warranty

Basic Two-Year Warranty and 90-Day Lamp Warranty

What Is Covered: Epson America, Inc. (“EPSON”) warrants to the first end user customer of the EPSON product enclosed with this limited warranty statement that the product, if purchased and used in the United States or Canada, conforms to the manufacturer’s specifications and will be free from defects in workmanship and materials for a period of two (2) years from the date of original purchase (except that the warranty period is 90 days for projector lamps).

What EPSON Will Do To Correct Problems: If you elect carry-in warranty service, please bring the product securely packaged in its original container or an equivalent, along with proof of the date of original purchase, to your EPSON Dealer or EPSON Customer Care Center. EPSON will, at its option, repair or replace on an exchange basis the defective unit, without charge for parts or labor. When warranty service involves the exchange of the product or of a part, the item replaced becomes EPSON property. The exchanged product or part may be new or previously repaired to the EPSON standard of quality. Exchange or replacement products or parts assume the remaining warranty period of the product covered by this limited warranty. However, each replacement lamp carries the limited 90-day warranty stated above.

What This Warranty Does Not Cover: This warranty covers only normal consumer use in the United States and Canada. 24-hour-per-day use causes unusual strain and is not considered normal use. This warranty does not cover consumables (e.g., fuses), other than lamps. EPSON is not responsible for warranty service should the EPSON label or logo or the rating label or serial number be removed or should the product fail to be properly maintained or fail to function properly as a result of misuse, abuse, improper installation, neglect, improper shipping, damage caused by disasters such as fire, flood, and lightning, improper electrical current, software problems, interaction with non-EPSON products, or service other than by an EPSON Authorized Servicer. Postage, insurance, or shipping costs incurred in presenting your EPSON product for carry-in warranty service are your responsibility. If a claimed defect cannot be identified or reproduced in service, you will be held responsible for costs incurred.

THE WARRANTY AND REMEDY PROVIDED ABOVE ARE EXCLUSIVE AND IN LIEU OF ALL OTHER EXPRESS OR IMPLIED WARRANTIES INCLUDING, BUT NOT LIMITED TO, THE IMPLIED WARRANTIES OF MERCHANTABILITY OR FITNESS FOR A PARTICULAR PURPOSE. SOME LAWS DO NOT ALLOW THE EXCLUSION OF IMPLIED WARRANTIES. IF THESE LAWS APPLY, THEN ALL EXPRESS AND IMPLIED WARRANTIES ARE LIMITED TO THE WARRANTY PERIOD IDENTIFIED ABOVE. UNLESS STATED HEREIN, ANY STATEMENTS OR REPRESENTATIONS MADE BY ANY OTHER PERSON OR FIRM ARE VOID. EXCEPT AS PROVIDED IN THIS WRITTEN WARRANTY, NEITHER EPSON AMERICA, INC. NOR ITS AFFILIATES SHALL BE LIABLE FOR ANY LOSS, INCONVENIENCE, OR DAMAGE, INCLUDING DIRECT, SPECIAL, INCIDENTAL OR CONSEQUENTIAL DAMAGES, RESULTING FROM THE USE OR INABILITY TO USE THE EPSON PRODUCT, WHETHER RESULTING FROM BREACH OF WARRANTY OR ANY OTHER LEGAL THEORY. IF THE REMEDY ABOVE FAILS, EPSON'S ENTIRE LIABILITY SHALL BE LIMITED TO A REFUND OF THE PRICE PAID FOR THE EPSON PRODUCTS COVERED BY THIS LIMITED WARRANTY.

In Canada, warranties include both warranties and conditions.

Some jurisdictions do not allow limitations on how long an implied warranty lasts and some jurisdictions do not allow the exclusion or limitation of incidental or consequential damages, so the above limitations and exclusions may not apply to you.

This warranty gives you specific legal rights, and you may also have other rights, which vary from jurisdiction to jurisdiction.

To locate the Authorized EPSON Servicer nearest you, call the EPSON ConnectionSM at (800) 637-7661 + PIN or (562) 276-4394 in the U.S. and (905) 709-3839 in Canada or write to: Epson America, Inc., P.O. Box 93012, Long Beach, CA 90809-3012.

Index

A

- A/V cable, 10, 22 to 26
- A/V Mute, 42, 53, 56 to 57, 75, 81
- About menu, 46, 55
- Accessories, 12, 84
- Adapters, Macintosh, 12, 17
- Advanced menu, 46, 53 to 54
- Air filter
 - cleaning and replacing, 65 to 66
 - purchasing, 12
- Anti-theft device, 12
- Aspect ratio, 50, 85
- Audio
 - adjusting volume, 51
 - cable, 8, 20, 81
 - connecting laptop, 20
 - menu, 20, 23, 46, 51, 81
 - problems, troubleshooting, 81
 - turning off, 42
- Audio Input setting, 20, 23, 46, 51, 81
- Auto button, 37, 49
- Auto Keystone correction, 15, 35, 46, 52
- Auto Setup setting, 37, 50

B

- Background Color setting, 53, 56 to 57, 60
- Battery tape, removing, 40
- Battery, replacing, 44
- Black background, 53
- Blackboard color mode, 36, 50
- Blank screen, 30 to 32, 75 to 77
- Blue background, 53
- Blurry image, 79
- Brightness, 7, 36, 54, 67, 75, 85
- Brightness Control setting, 36, 54, 75
- Brightness setting, 36, 49, 75, 80

C

- Cables, 10 to 12
- Camcorder, connecting to, 22 to 24
- Carrying case, 10 to 12, 70
- Ceiling
 - mount, 12, 15
 - projection, 15, 54
- Cleaning
 - air filter, 65 to 66
 - lens, 64
 - projector case, 64
- Color
 - adjusting, 36 to 37, 49 to 50, 54
 - problems, 80
 - specifications, 85
- Color Mode, 36 to 37, 49 to 50
- Component video cable, 11 to 12, 22
- Component video source, selecting, 26
- Composite video cable, 22 to 23
- Computer
 - cable, 10, 16 to 18
 - connecting to projector, 16 to 21
 - connector pin assignments, 90
 - source, selecting, 18
 - support, 7
- Computer/Component Video port, 17, 25, 41
- Computer1/2 button, 30, 41, 76
- Connecting projector
 - to a computer, 16 to 20
 - to a high-end workstation, 21
 - to a video source, 22 to 26
- Connector pin assignments, 90
- Contrast setting, 49, 85

D

Declaration of Conformity, 94
Default password, 58
Default settings, restoring, 47, 61
Digital camera, connecting to, 22 to 24
Dimensions, 86
Directional buttons, 43, 47
Distance from projector to screen, 14 to 15, 85
Documentation, using, 9
DVD player, connecting to, 22 to 26
Dynamic color mode, 36, 49

E

Electrical specifications, 86
Enter button, 43, 47
Entering the password, 60 to 61
Environmental specifications, 87
EPSON
 accessories, 12, 84
 Extra Care Road Service, 10
 PrivateLine Support, 9, 84
 Store, 12, 84
 technical support, 9, 83 to 84
Esc button, 43, 48
Extra Care Road Service, 10
E-Zoom button, 42 to 43

F

FCC compliance statement, 95
Filter, cleaning and replacing, 65 to 66
Focusing, 33
Foot release levers, 34
Formats, video, 88 to 89
Freeze button, 42
Front projection, 14 to 15
Front/Ceiling setting, 15, 54

H

Height of image, adjusting, 34
Help, 9, 83 to 84
Help system, using, 72 to 73
High brightness, 36, 54, 67, 75, 85

I

iBook, connecting to, 16 to 18
iMac, connecting to, 11, 16 to 18
Image
 adjusting, 33 to 37, 48 to 50
 capturing and saving in projector, 56 to 57
 correcting shape of, 35, 52, 78
 fitting on screen, 37, 50
 focusing, 33
 freezing, 42
 height, adjusting, 15, 34
 menu, 46, 48 to 50
 positioning, 34, 49
 problems, 75 to 80
 raising, 34
 selecting source, 18, 23 to 26, 29 to 30
 shape, correcting, 35, 52, 78
 size and projection distance, 14 to 15, 85
 turning off, 42
 zooming, 33, 42 to 43
Input Signal setting, 50
Input signal, selecting, 26, 30

K

Kensington anti-theft device, 12
Keystone correction, 35, 52, 78, 85

L

Lamp
 automatic shutoff, 37
 brightness, 7, 54, 67, 75, 85
 number of hours used, 55, 67, 69
 replacing, 67 to 70
 specifications, 86
 status light, 73 to 74
 timer, resetting, 69 to 70
Language setting, 54, 72
Laptop computer
 connecting to, 16 to 18
 displaying on, 31 to 32, 76
Laser disc player, connecting to, 22 to 26
LCD panels, 7, 85

Lens
cap, 28, 38
cleaning, 64
specifications, 85
Lights, status, 73 to 74
Living Room color mode, 36, 50
Logo
creating, 56 to 57
displaying, 56 to 60
enabling, 53, 59 to 60
password protection, 53, 56 to 61
Low brightness, 36, 54, 67, 75, 85

M

Macintosh
adapters, 12, 17
connecting, 16 to 20
Manuals, 9
Menus
About, 46, 55
Advanced, 46, 53 to 54
Audio, 46, 51
changing settings, 46 to 48
Image, 46, 48 to 50
Reset All, 46, 61
Setting, 46, 52 to 53
User's Logo, 46, 56 to 57
using, 46 to 48
Message setting, 52
Mouse
compatibility, 86
connecting cable, 19
using remote control as, 43

N

Noise level, 85

O

Options for projector, 12

P

Page up and Page down buttons, 43
Password
default, 58
enabling, 58 to 61
entering, 60 to 61
logo protection, 53, 56 to 61
problems, 82
prompt, 29, 60
protection, 58 to 61
request code, 61
setting, 58 to 59
turning on, 59 to 60
User's Logo protection, 53, 56 to 61
Picture source, selecting, 18, 30, 41
Pin assignments, connector, 90
Position setting, 49
Positioning
image, 34, 49
projector, 14 to 15
Power
button, 29, 37
consumption, 86
light, 28, 73 to 74
saving, 37, 53
supply, 86
PowerBook, connecting to, 16 to 18
Presentation color mode, 36, 49
Presenters Online, 9, 83
PrivateLine Support, 9, 84
Problems
color, 80
image, 75 to 80
password, 82
remote control, 82, 93
sound, 81
USB, 83
Projection lamp, *see* Lamp

Projector

- carrying case, 10 to 12, 70
- cleaning, 63 to 66
- distance from screen, 14 to 15, 85
- feet, adjusting height with, 34
- lamp specifications, 86
- options, 12
- password protection, 58 to 61
- positioning, 14 to 15
- resolution, 7, 85
- shutting off, 37 to 38
- specifications, 85 to 90
- transporting, 70
- troubleshooting, 71 to 81
- turning off, 37 to 38
- turning on, 28 to 29
- unpacking, 10
- viewing information about, 55

Q

Quick Setup sheet, 9

R

Raising image, 34

RCA A/V cable, 10, 22 to 26

Rear

- projection, 15, 53 to 54
- setting, 15, 53 to 54

Rear/Ceiling setting, 15, 53 to 54

Registration, 10

Remote control

- problems, 82, 93
- removing tape, 40
- replacing battery, 44
- specifications, 86
- storage compartment, 8, 40, 60
- using, 39 to 43
- wireless mouse, using as, 43

Replacing

- air filter, 65 to 66
- lamp, 67 to 70

Request code, password, 61

Reset All menu, 46, 61

Resetting menu options, 61

Resolution, 7, 21, 85

S

Safety instructions, 91 to 92

Screen logo, *see* User's Logo

Screen, distance from projector, 14 to 15, 85

Screens, portable, 12

Setting a password, 59

Setting menu, 46, 52 to 53

Sharpness setting, 49

Sleep mode, 37, 53

Sound, *see* Audio

Source button, 29 to 30, 41

Source, selecting, 29 to 30, 41

Speaker, specifications, 85

Specifications

- brightness, 7, 85
- electrical, 86
- environmental, 87
- lamp, 86
- lens, 85
- remote control, 86
- resolution, 7, 85
- safety, 87

sRGB color mode, 36, 50

Standby mode, 37, 53

Start Here kit, 9

Startup screen

- creating, 56 to 57
- displaying, 56 to 60
- protecting, 58 to 60
- user's logo, *See* User's Logo

Startup Screen setting, 54

Status lights, 73 to 74

Stopping action, 42

Storing remote control, 60

Support, 9, 83 to 84

S-Video cable, 11, 22

S-Video/Video button, 29 to 30, 41

Switching picture source, 30, 41

Sync, adjusting, 49, 79 to 80

T

- Technical support, 9, 83 to 84
- Temperature
 - light, 73 to 74
 - requirements, 87
- Theater color mode, 36, 50
- Timer, lamp, 69 to 70
- Tint setting, 49
- Tracking, adjusting, 49, 79 to 80
- Transporting projector, 70
- Troubleshooting
 - cut-off image, 37
 - image and sound problems, 75 to 81
 - projector problems, 71 to 81
 - remote control problems, 82
- Turning off picture, 42
- Turning off projector, 37 to 38
- Turning on password, 59 to 60
- Turning on projector, 28 to 29
- Turning on User's Logo, 59 to 60
- Typing the password, 60 to 61

U

- Unpacking projector, 10
- USB mouse cable, 10, 19, 83
- User's Logo
 - creating, 56 to 57
 - displaying, 46, 56 to 60
 - enabling, 53, 59 to 60
 - password, 58 to 61
 - protecting, 53, 58 to 61
 - turning on, 59 to 60

V

- VCR, connecting to, 22 to 26
- VGA computer cable, 10, 16 to 18
- Video
 - display settings, 55
 - formats, supported, 7, 88 to 89
 - port pin assignments, 90
 - source, connecting to, 22 to 26
 - source, selecting, 23 to 26, 29 to 30, 41
- Video Signal setting, 50
- Volume, adjusting, 51

W

- Warning light, 73 to 74
- Warranty, 10, 96 to 97
- Weight, 86
- Wireless mouse, 19, 43
- Workstations, connecting projector to, 21

Y

- YCbCr, 26
- YPbPr, 26

Z

- Zoom ratio, 85
- Zooming image, 33, 42 to 43

